

Pro-face

Compact Panel Computer
PS-3701A
(Eden™ ESP6000-667MHz Model)

User Manual

Introduction

The PS-3701A (Eden™ ESP6000 - 667MHz Model) (PS-A) of Compact Panel Computers are multipurpose factory automation (FA) computers, which embody Pro-face's latest, cost-effective architecture. Before using the PS-A, read this manual thoroughly to familiarize yourself with the PS-A's operation procedures and functions.

NOTE

1. It is forbidden to copy the contents of this manual in whole, or in part, without the permission of the Digital Electronics Corporation.
2. The information in this manual is subject to change without notice.
3. This manual was written with care; however, if you should find any error or omissions, please contact Digital Electronics Corporation and inform them of your findings.
4. Regardless of the above clause, Digital Electronics Corporation shall not be held responsible for any damages or third-party claims for damages or losses resulting from the use of this product.

Product names used in this manual are the trademarks of their respective manufacturers.





© Copyright 2003 Digital Electronics Corporation. All rights reserved.

Essential Safety Precautions







This manual includes the following cautions concerning procedures that must be followed to operate the PS-A correctly and safely. Prior to operating the PS-A, be sure to read this manual and any related materials thoroughly to understand the correct operation and functions of this unit.

Safety Icons

To allow you to use the PS-A correctly, throughout this manual, the following icons are provided next to operations requiring special attention. These icons are used to describe the following situations:

 WARNING	Failure to fully comply with points indicated by this symbol may result in death or serious injury.
 CAUTION	Failure to fully comply with points indicated by this symbol may result in injury or equipment damage.
	Indicates actions or procedures that should NOT be performed.
	Indicates actions or procedures that MUST be performed to ensure proper operation.

— WARNING —

-  To avoid the possibility of an electric shock, be sure to disconnect the power cord to the PS-A before connecting it to the main power supply.
-  A fire or electrical shock may occur if voltages used with the PS-A are beyond the specified range. Be sure to use only the specified voltage.
-  Before opening the PS-A's protective cover, be sure to turn the unit's power OFF. This is because the PS-A's internal parts carry high voltages.
-  To avoid fires or electrical hazards, do not modify the PS-A in any way.
-  Do not create touch panel switches that are used to either control or to ensure the safety of equipment and personnel. Mechanical switches, such as an emergency stop switch, a deadman (two-handed) start switch, etc., must be installed and operated via a separate control system.
-  Do not create touch panel switches which could possibly endanger the safety of humans and equipment. This is due to the possibility of a malfunction in the PS-A or its cable(s), causing the output of a signal that could result in a major accident. All of a system's major, safety-related switches should be designed to be operated separately from the PS-A.

⊘ After the PS-A's backlight burns out, unlike the PS-A's "Standby Mode", the touch panel is still active. If the operator fails to notice that the backlight is burned out and touches the panel, a potentially dangerous machine miss-operation can occur.

If your PS-A's backlight suddenly turns OFF, use the following steps to determine if the backlight is actually burned out.

- 1) If your PS-A is not set to "Standby Mode" and the screen has gone blank, your backlight is burned out.
- 2) Or, if your PS-A is set to Standby Mode, but touching the screen does not cause the display to reappear, your backlight is burned out.

❗ If metal particles, water or other types of liquids contact any of the PS-A's internal parts, immediately turn the unit's power OFF, unplug the power cord, and contact either your PS-A distributor or the Digital Electronics Corporation.

❗ Read and understand Chapter 2 "Hardware Installation" thoroughly in order to select an appropriate installation location for the PS-A.

❗ Before either plugging in or unplugging interface connector, be sure to turn the PS-A's power OFF.

⊘ To prevent a possible explosion, do not install the PS-A in areas containing flammable gases.

⊘ The PS-A is not appropriate for use with aircraft control devices, aerospace equipment, central trunk data transmission (communication) devices, nuclear power control devices, or medical life support equipment, due to these devices' inherent requirements of extremely high levels of safety and reliability.

❗ When using the PS-A with transportation vehicles (trains, cars and ships), disaster and crime prevention devices, various types of safety equipment, non-life support related medical devices, etc. redundant and/or fail-safe system designs should be used to ensure the proper degree of reliability and safety.

 **CAUTION**

⊘ Do not push on the PS-A's screen too strongly, with either your finger or with a hard object. Excessive pressure can scratch, crack or damage the screen. Also, do not use a pointed object, such as a mechanical pencil or screwdriver, to press any of the touch panel's switches, since they can damage the display.

⊘ If the screen becomes dirty or smudged, moisten a soft cloth with diluted neutral detergent, wring the cloth well, and wipe the display. Do not use thinner or organic solvents.

⊘ Avoid exposing the PS-A to, or operating the PS-A in direct sunlight, high temperatures and humidity, and in areas where excessive dust and vibration will occur.

⊘ Avoid using the PS-A in areas where sudden, extreme changes in temperature can occur. This may cause condensation to form inside the unit, possibly leading to an accident.

⊘ To prevent the PS-A from overheating, be sure its air circulation vents are clear and clean, and keep the unit's operation area well-ventilated.

⊘ Avoid operating or storing the PS-A near chemicals, or where chemicals can come into contact with the unit.







CAUTION

When PS-A Hard Disk (HDD) data is lost:

- ❗ The Digital Electronics Corporation cannot be held responsible or provide any compensation for damage(s) caused by the loss of data stored in the PS-A's hard disk drive (HDD). It is therefore strongly suggested that all important data and software be backed up regularly to an external data backup device.
 - ❗ Please be aware that the Digital Electronics Corporation bears no responsibility for any damages resulting from the customer's application of this unit's hardware or software.
 - ❗ Since the PS-A unit's hard disk drive (HDD) is a consumable item, i.e. it has a limited lifetime, be sure to back up its data regularly and prepare a spare Hard Disk Drive (HDD) unit.
 - ❗ In order to extend the lifetime of the hard disk, Pro-face recommends you set the Windows [Control panel]-[Power Management option]-[Turn off hard disks] selection to turn the hard disk off when the unit is not being operated. A setting of 5 minutes is recommended.
 - ❗ To prevent file data damage, be sure to shut down the PS-A's OS before turning OFF the main power.
 - ⊘ After turning OFF the PS-A's power, wait until the internal hard disk drive (HDD) stops spinning before turning on the power again (approx. 5 seconds).
-
- The PS-A's LCD contains a strong irritant. If the panel is ever cracked and the LCD's liquid contacts your skin, be sure to wash it with running water for at least 15 minutes. If any of this liquid should enter your eye, be sure to flush your eye with running water for more than 15 minutes and see a doctor as soon as possible.
 - The brightness of the LCD screen will depend on the screen's current display and the LCD's contrast adjustment. Any brightness variations that result are normal for LCD displays.
 - There are minute grid-points (Dark or Light points) on the LCD surface. These points are not defects and are a part of the PS-A unit's design.
 - The displayed color will look different when viewed from an angle outside the specified view angle. This is also normal.
 - When installing this unit, be sure that the screen is viewable from within the designated viewing angles. The screen image being difficult to see from outside its recommended viewing angle is normal.
 - Displaying a single screen image for long periods of time can cause an afterimage to remain on the screen. To correct this, turn the unit OFF for 5 to 10 minutes, then ON again. This phenomenon is a common attribute of LCD displays, and is not a defect. To prevent this effect, you can:
 - 1) Use the Display OFF feature; if the same image is to be displayed for a long period of time.
 - 2) Change the screen display periodically to prevent the displaying of a single image for a long period of time.

Information Symbols

This manual uses the following icons:

	Indicates a warning or a product limitation. Be sure to follow the instructions given with this icon to insure the safe operation of the PS-A.
	Contains additional or useful information.
	Indicates terms or items that require further explanation. See the footnote on that page.
	Indicates pages containing related information.
	Indicates steps used to accomplish a given task. Be sure to follow these steps in the order they are written.
	Refers collectively to the Compact Panel Computers PS-3701A (Eden™ ESP6000 - 667MHz Model) units.

Package Contents

The following items are included in the PS-A's package. Before using the PS-A, please confirm that all items listed here are present.

PS-A

(PS3701A-T41-DU-E66)

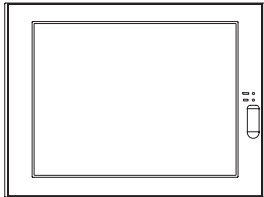

Moisture Resistant Gasket (1)



Installation Fasteners (4/set x 2)

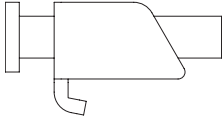

USB Cable Clamp (2)

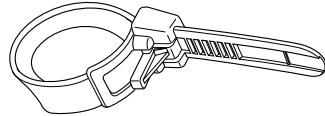

Power Plugg (1)

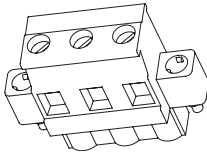

CD-ROM (1)

PS370XA-E66 User Manual & Driver CD



Installation Guide (1)

(Japanese/English)



IMPORTANT

- Be careful when installing the PS-A not to damage the built-in HDD.

NOTE

- The CD-ROM included in this package contains a User Manual, RAS-API Reference Manual, and PS-A Series Utility and Driver files.

This unit has been carefully packed, with special attention to quality. However, should you find anything damaged or missing, please contact your local PS-A distributor immediately.

When you order a PS-A unit built to your specifications, that PS-A package should include each optional item's Installation Guide. Please use that guide to check the contents of each optional item's package.

UL/c-UL (CSA) Application Notes

PS3701A-T41-DU-E66 unit is UL/c-UL listed product (UL File No. E220851). Please pay special attention to the following instructions when applying for UL/c-UL approval for machinery which includes any of PS-A units.

The PS-A conforms as a component to the following standards:

■ **UL508** Industrial Control Equipment

■ **CAN Std C22.2 No.14-1995 CAN/CSA22.2 No.6.950**

PS3701A-T41-DU-E66 (UL Registration Model No.:3280022-01)

- Equipment with a PS-A unit mounted in it requires UL/c-UL evaluation for the combination of the PS-A and equipment.
- The PS-A must be used as a built-in component of an end-use product.
- Use the PS-A indoors only.
- When connecting the PS-A's power cord, be sure to use a cord that is appropriate for the current and voltage used and that has conductive wires that are AWG18 or larger.
- When using the PS-A in an end-use product, be sure to install the PS-A unit's power cut-off switch where the operator can easily reach it.
- Danger of explosion if backup battery is incorrectly replaced. Should be replaced only with same or equivalent type recommended by the manufacturer. Dispose of used batteries according to the manufacturer's instructions.
- Be sure the unit the PS-A is built into uses a UL508 compatible structure.

CE Marking Notes

PS3701A-T41-DU-E66 unit is CE marked, EMC compliant product.

<Complies with the following Standards>

■ Safety

EN60950

■ EMI

EN61000-6-4, EN55011(Group 1, Class A)

■ EMS (EN61000-6-2/EN61131-2)

EN61000-4-2, EN61000-4-3, EN61000-4-4, EN61000-4-5, EN61000-4-6, EN61000-4-8, EN61000-4-12

■ FCC

47CFR Part 15 Class A

If the following requirements are not met, the PS-A may fail to meet EN60950 standard requirements.

- The PS-A must be used as a built-in component of an end-use product.
- Use the PS-A indoors only.
- When connecting the PS-A's power cord, be sure to use a cord that is appropriate for the current and voltage used and that has conductive wires that are AWG18 or larger.
- When using the PS-A in an end-use product, be sure to install the PS-A unit's power cut-off switch where the operator can easily reach it.
- There is a danger of explosion if the backup battery is incorrectly replaced. This battery should be replaced only with same or equivalent type recommended by the manufacturer. Dispose of used batteries according to the manufacturer's instructions.
- Be sure the PS-A unit's enclosure is an EN60950 approved sheet steel structure.

Memo

Table of Contents

Introduction.....	1
Essential Safety Precautions.....	2
Information Symbols.....	5
Package Contents.....	6
UL/c-UL (CSA) Application Notes.....	8
CE Marking Notes.....	9

CHAPTER 1 Overview

1.1 Prior to Operating the PS-A Unit.....	1-2
1.2 PS-A Unit System Configuration.....	1-3
1.2.1 Using the USB Interface (located on the front face).....	1-4
1.3 PS-A Unit Part Names and Features.....	1-5
1.4 Interfaces.....	1-7
1.4.1 Serial Interface (COM1/COM2).....	1-7
1.4.2 Printer Interface (LPT1).....	1-12
1.5 PS-A Unit External Views and Dimensions.....	1-13
1.5.1 PS-A Unit.....	1-13
1.5.2 External Dimensions (with Installation Fasteners installed).....	1-13
1.5.3 Panel Cut Dimensions.....	1-14
1.5.4 Installation Fasteners.....	1-14

CHAPTER 2 Hardware Installation

2.1 Installation.....	2-2
2.1.1 Removing the PS-A Unit's Cover.....	2-2
2.1.2 PS-A Internal View.....	2-3
2.1.3 Main Memory Installation.....	2-3
2.1.4 PCMCIA Unit Installation.....	2-4
2.1.5 USB Cable Clamp Installation.....	2-5
2.1.6 CF Card Installation and Removal.....	2-7
2.2 Installing the PS-A Unit.....	2-9
2.2.1 Installation Caution.....	2-9
2.2.2 Installation Procedures.....	2-11
2.3 Wiring the PS-A.....	2-15
2.3.1 Connecting the Power Cord.....	2-15
2.3.2 Power Supply Cautions.....	2-16
2.3.3 Grounding Cautions.....	2-18
2.3.4 Cautions When Connecting I/O Signal Lines.....	2-18

CHAPTER 3 System Setup

- 3.1 Setup Procedures 3-2
- 3.2 System Parameters 3-3
 - 3.2.1 Standard CMOS Features.....3-3
 - 3.2.2 IDE HDD Auto-Detection3-5
 - 3.2.3 Advanced BIOS Features3-6
 - 3.2.4 Advanced Chipset Features.....3-9
 - 3.2.5 Integrated Peripherals.....3-12
 - 3.2.6 Power Management Setup3-16
 - 3.2.7 PnP/PCI Configurations3-18
 - 3.2.8 IRQ Resources3-19
 - 3.2.9 System Monitor Setup.....3-20
 - 3.2.10 Frequency/Voltage Control3-21
 - 3.2.11 Load Fail-Safe Defaults.....3-21
 - 3.2.12 Load Optimized Defaults.....3-22
 - 3.2.13 Set Supervisor Password.....3-22
 - 3.2.14 Set User Password3-22
 - 3.2.15 Save & Exit Setup3-22
 - 3.2.16 Exit Without Saving.....3-22

CHAPTER 4 Setting up Your PS-A Unit

- 4.1 CD-ROM Contents..... 4-2
 - 4.1.1 Software4-2
- 4.2 Setting Up Your PS-A Unit..... 4-3
 - 4.2.1 Setup Procedures4-3
 - 4.2.2 Setting Up an HDD with Pre-installed OS.....4-4
- 4.3 Installing Drivers 4-6
- 4.4 Special Application Program Features..... 4-7
 - 4.4.1 Uninstalling Utility Software4-9
- 4.5 When Using Windows® 2000/Windows® XP 4-10
 - 4.5.1 Automatic System Log-on Setup4-10
 - 4.5.2 Uninterrupted Power Supply System (UPS)4-11
 - 4.5.3 Changing System Settings.....4-11
 - 4.5.4 NTFS File System Conversion.....4-11

CHAPTER 5 Monitoring Features

- 5.1 RAS Features 5-2
 - 5.1.1 PS-A RAS Features5-2
 - 5.1.2 RAS Feature Details5-3
 - 5.1.3 RAS Feature Overview5-5

5.2	System Monitor/RAS Features	5-6
5.2.1	Setup Procedures	5-6
5.2.2	System Monitoring Property Settings (PSA_Wps.exe)	5-7
5.2.3	System Monitoring Operation (PSA_Smon.exe).....	5-9
5.2.4	Error Messages	5-12
5.3	Error Displays When Using Event Viewer.....	5-14
5.3.1	Error Message Display	5-14
5.3.2	Error Type/Location	5-15
5.3.3	Error Action.....	5-15
5.4	Remote RAS.....	5-16
5.4.1	System Configuration	5-16
5.4.2	Installation Procedures	5-16
5.4.3	Setup and Preparation of the Remote RAS Feature.....	5-17
5.4.4	Read and Write of the System Monitor/RAS Feature	5-19
5.4.5	Restrictions	5-22
5.5	Remote Shutdown Feature.....	5-23

CHAPTER 6 Maintenance and Inspection

6.1	Regular Cleaning	6-2
6.1.1	Cleaning the Display	6-2
6.1.2	Installation Gasket Replacement	6-3
6.2	Changing the PS-A Backlight	6-4
6.3	Periodic Inspection Items.....	6-7

CHAPTER 7 Specifications

7.1	General Specifications	7-2
7.1.1	Electrical Specifications	7-2
7.1.2	Environmental Specifications	7-2
7.1.3	Structural Specifications.....	7-4
7.2	Performance Specifications	7-5
7.2.1	Performance Specifications	7-5
7.2.2	Display Functions	7-6
7.2.3	Clock Accuracy	7-6

CHAPTER AppAppendices

A.1	Hardware Configuration.....	App-2
A.1.1	I/O Map.....	App-2
A.1.2	Memory Map	App-3
A.1.3	Interrupt Map	App-4
A.2	List of Optional Devices	App-5

Memo

1



Overview

1. Prior to Operating the PS-A Unit
2. PS-A Unit System Configuration
3. PS-A Unit Part Names and Features
4. Interfaces
5. PS-A Unit External Views and Dimensions

1.1 Prior to Operating the PS-A Unit

The following explanation shows the preparation steps required prior to operating the PS-A.

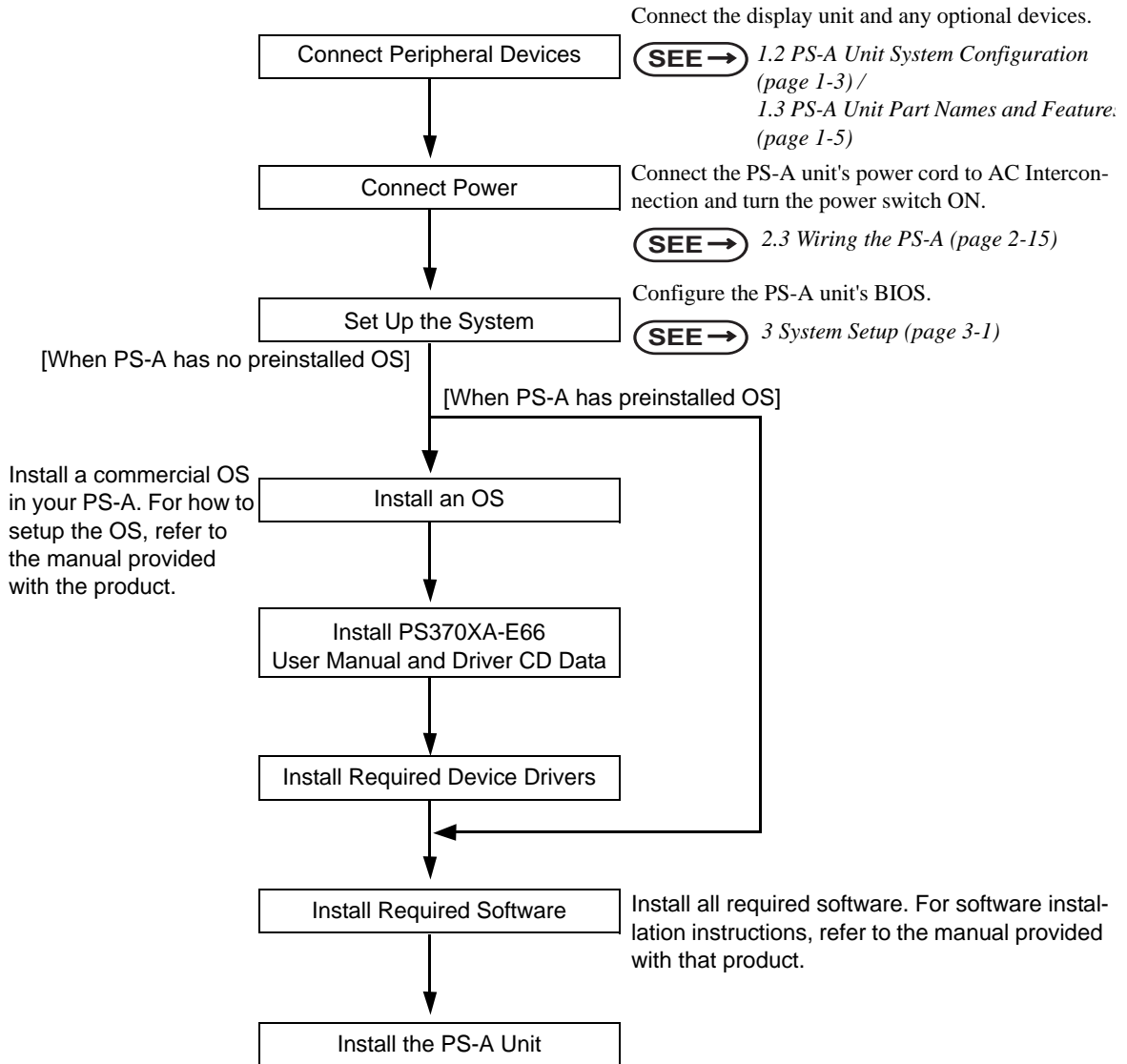

IMPORTANT

- After hardware setup is completed, the OS must be used to create partitions and format (initialize) the HDD before any data or applications can be saved to the hard disk drive. For details concerning these procedures, refer to the OS manufacturer's instruction manual.
- Whenever you turn the PS-A unit's power OFF, wait until the internal HDD stops spinning (approximately 5 seconds) before turning the power ON again.
- The PS-A's hard disk is designed for use with the Windows® 2000, Windows® XP. Other operating systems do not support this driver software, etc.

1.2 PS-A Unit System Configuration

The following chart shows the range of peripheral items connected to the PS-A.

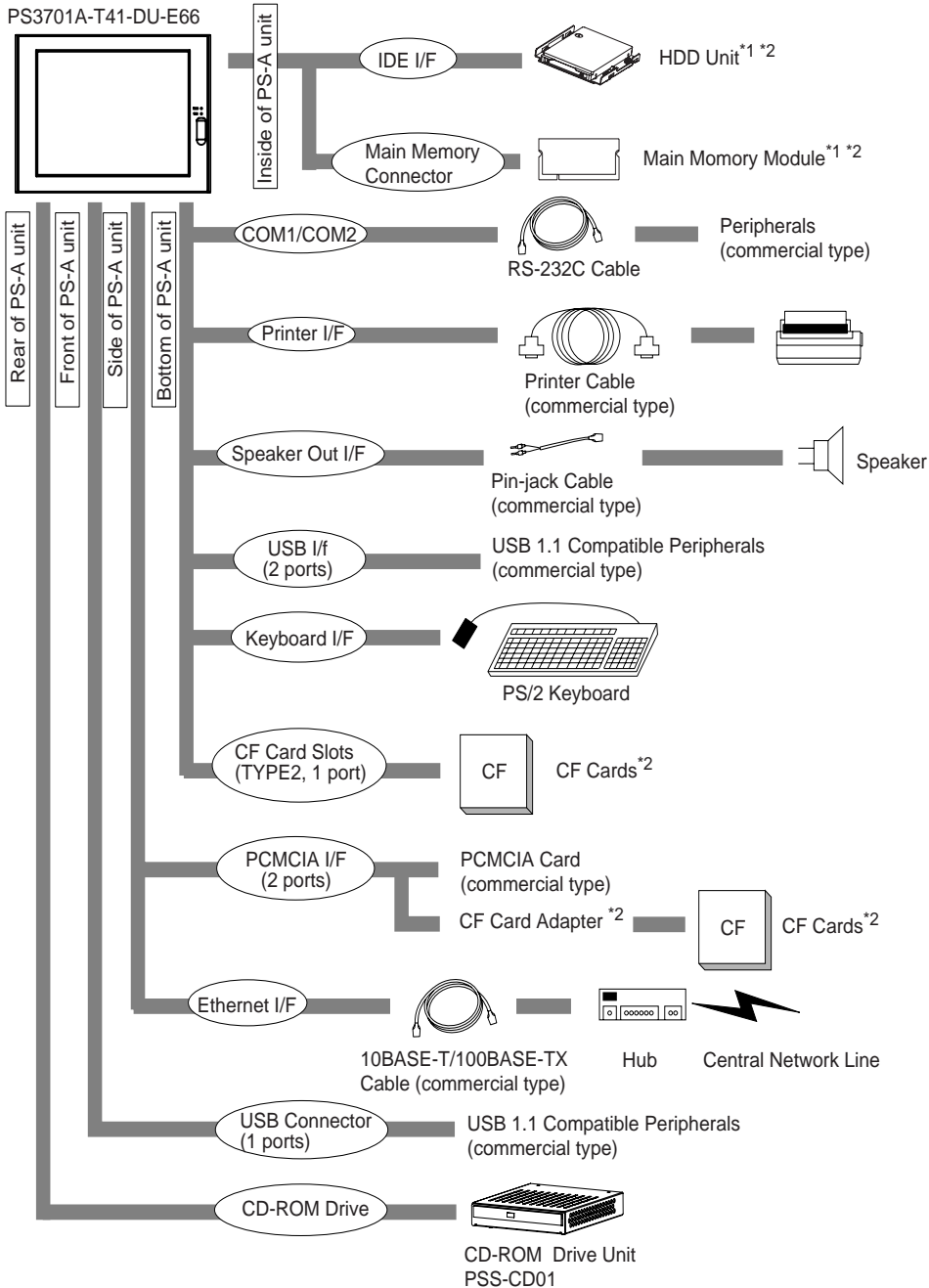

*1 Built-in accessory only

*2 Digital Electronics Corporation's optional devices and commercial products.
Please refer to A.2 List of Optional Devices.

IMPORTANT

- This diagram shows only the PS-A's internal layout and connectable devices. The user's actual design may differ.

1.2.1 Using the USB Interface (located on the front face)

IMPORTANT

- When using multiple commercial-type USB peripheral devices, be sure to use a commercial-type USB HUB. However, USB HUBs cannot be connected to each other.

(Connection example)

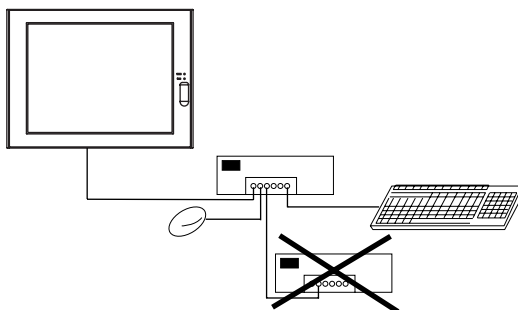

1.3 PS-A Unit Part Names and Features

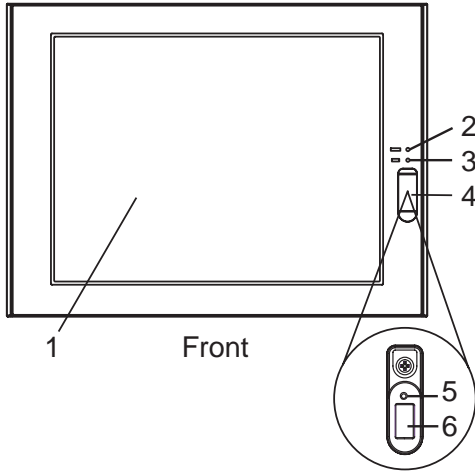

- 1 : Display / Touch Panel
 2 : Power Lamp LED (POWER)

LED	PS-A Status
Green	Normal Operation (Power On)
Orange	System Monitor Error Touch Panel Self Test Error
Orange/Red	Backlight is not functioning

- 3 : IDE Access Lamp

LED	PS-A Status
Green	Currently using IDE I/F

- 4 : Front Packing
 5 : Hardware Reset Switch (RESET)
 Pressing this switch re-starts the PS-A unit.

- 6 : USB Interface (1 port)
 Provides a USB 1.1 compatible connection.
 Connect a USB connectable device here.

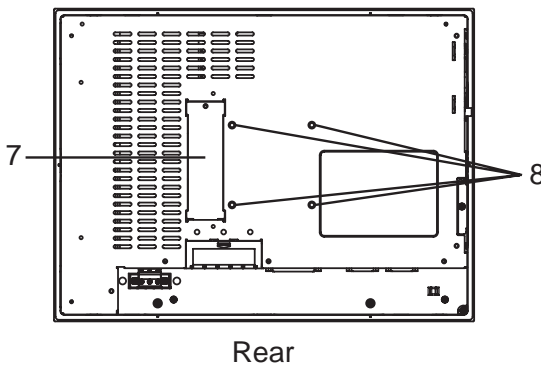

- 7 : CD-ROM Drive Interface Cover
 This cover is removed when installing optional CD-ROM Drive unit (PSS-CD01).

- 8 : Arm Attachment Screw Holes (VESA 75mm)

- 9 : PCMCIA Interface (PCMCIA)(2 ports)

- 10 : Ethernet Interface
 10 BASE-T /100 BASE-TX Auto Changeover

- 11 : Rear Cover
 This cover is removed when installing an HDD unit, main memory, or Expansion unit (PCI).

- 12 : Keyboard Connector (KEYBOARD)
 Connect a PS/2-compatible keyboard here.

- 13 : USB Interface (2 ports)
 Provides a USB 1.1 compatible connection.
 Connect a USB connectable device here.

- 14 : Serial Interface (COM2)
 [RS-232C/RS-422/RS-485 Changeover,
 +5V/RI Changeover]

- 15 : Serial Interface (COM1)
 [+5V/RI Changeover]

- 16 : Speaker Output Connector (SPEAKER OUT)

- 17 : Printer Connector (LPT1)

- 18 : CF Card Interface Cover

- 19 : Power Input Terminal Block

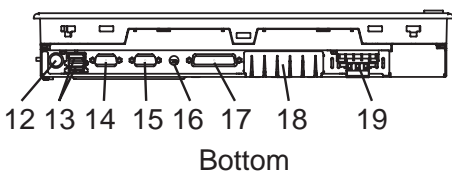
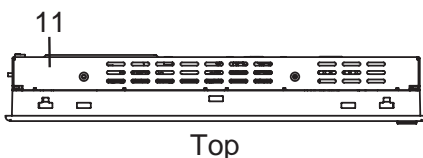
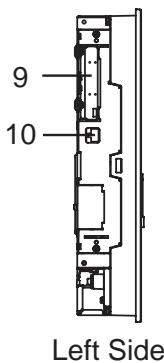

IMPORTANT

- Prior to attaching peripheral units to the PS-A, be sure the PS-A's power cord is disconnected from the main power supply.
- To prevent an electrical shock, be sure to disconnect the PS-A's power cord from the power supply before connecting the cord or any peripheral devices to the PS-A.

1.4 Interfaces

1.4.1 Serial Interface (COM1/COM2)

◆ COM1

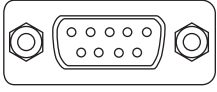
Pin Arrangement	PIN#	Signal	Condition	Direction
	1	CD	Carrier Detect	Input
	2	RXD	Receive Data	Input
	3	TXD	Send Data	Output
	4	DTR	Data Terminal Ready	Output
	5	GND	Signal Ground	-
	6	DSR	Data Set Ready	Input
	7	RTS	Request Send	Output
	8	CTS	Clear Send	Input
	9	RI / +5V	Ring Indicate	In/Output
	FG	FG	Frame Ground	-

To change the RI/+5V setting of #9 pin, open the PS-A unit's rear cover and set the dip switch (DIPSW2) to the desired position.

SEE → *Dip Switches (page 1-10)*

NOTE • Use inch type (#4-40UNC) threads to hold the cable's set (fastening) screws in place.

◆ COM2

COM2 can be changed to either RS-232C, RS-422 or RS-485. The default setting is RS-232C. To change this setting to RS-422 or RS-485, open the PS-A unit's rear cover and set the dip switch (DIPSW2) to the desired position.

SEE → *Dip Switches (page 1-10)*

(RS-232C)

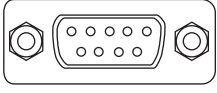
Pin Arrangement	PIN#	Signal	Condition	Direction
	1	CD	Carrier Detect	Input
	2	RXD	Receive Data	Input
	3	TXD	Send Data	Output
	4	DTR	Data Terminal Ready	Output
	5	GND	Signal Ground	-
	6	DSR	Data Set Ready	Input
	7	RTS	Request Send	Output
	8	CTS	Clear Send	Input
	9	RI / +5V	Ring Indicate/+5V - Power Supply for Exter-	In/Output
	FG	FG	Frame Ground	-

When RS-232C mode, the RI/+5V setting of #9 pin can be changed. To change this setting, open the PS-A unit's rear cover and set the dip switch (DIPSW2) to the desired position.

SEE → *Dip Switches (page 1-10)*

(RS-422)

Pin#	Signal	Condition	Direction
1	RXA	Receive Data (+)	Input
2	RXB	Receive Data (-)	Input
3	TXA	Send Data (+)	Output
4	NC	No Connection	-
5	GND	Ground	-
6	NC	No Connection	-
7	TXB	Send Data (-)	Output
8	NC	No Connection	-
9	NC	No Connection	-
FG	FG	Frame Ground	-

RS-485

Pin#	Signal	Condition	Direction
1	DATA+	Send/Receive Data (+)	In/Output
2	DATA-	Send/Receive Data (-)	In/Output
3	NC	No Connection	-
4	NC	No Connection	-
5	GND	Signal Ground	-
6	NC	No Connection	-
7	NC	No Connection	-
8	NC	No Connection	-
9	NC	No Connection	-
FG	FG	Frame Ground	-

IMPORTANT

- No. 5 pin (GND) for RS-232C (COM1,COM2) is the signal ground. Be sure to connect the GND terminal to the other unit's SG (signal ground) terminal.
- Be sure to confirm what settings will be used by the other device when setting the switches. Failure to do so can result in a unit malfunction or damage.
- Whenever changing any PS-A switch settings, be sure to first turn the PS-A's power supply OFF. Failure to do so can cause a PS-A malfunction.
- Connect the FG terminal line to the connector cover's PS-A connector attachment screw.
- FG and SG terminals are internally connected in the PS-A. When connecting to another device, be sure to create an SG shorting loop in your system.

NOTE

- Use inch type (#4-40UNC) threads to hold the cable's set (attachment) screws in place.

◆ Dip Switches

To set the Dip switch, remove the PS-A's Rear Cover and locate the following switches, next to the PS-A's circuit board. For information about attaching/removing the Rear Cover,

SEE → 2.1.1 Removing the PS-A Unit's Cover (page 2-2)

The factory settings are all OFF.

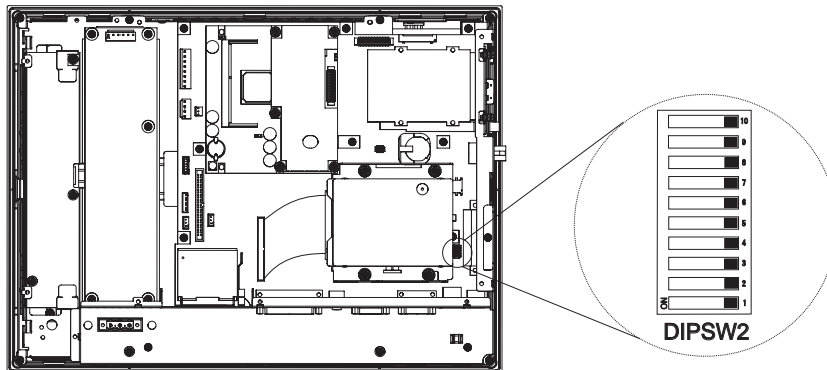

Inside of PS-A unit

Dip Switches	Description	ON	OFF	RS-232C (COM1)	RS-232C (COM2)	RS-422 (COM2)	RS-485 (COM2)
1	Changes #9 pin (RI <-> +5V)	+5V 500mA external output possible	RI	ON/OFF	ON/OFF	ON/OFF	ON/OFF
2	Changes COM2's communication method	RS-422/RS-485	RS-232C	OFF	OFF	ON	ON
3	Changes COM2 (RS-232C) #9 pin (RI <-> +5V)	+5V 500mA external output possible	RI	ON/OFF	ON/OFF	ON/OFF	ON/OFF
4	Changes TX data's output mode	TX data output is NOT controlled via the RTS signal	TX data output is controlled via the RTS signal. (normally output)	OFF	OFF	ON/OFF	ON
5	Switches the TX termination resistance ON/OFF	Inserts termination resistance of 220Ω between TXA and TXB.	No termination	OFF	OFF	ON	ON/OFF ^{*1}
6	Switches the RX termination resistance ON/OFF	Inserts termination resistance of 220Ω between RXA and RXB.	No termination	OFF	OFF	ON	ON/OFF ^{*1}
7	Switches the shorting of TXA and RXA ON or OFF	Shorts TXA and RXA (RS-485 mode)	No shorting (RS-422 mode)	OFF	OFF	OFF	ON

8	Switches the shorting of TXB and RXB ON or OFF	Shorts TXB and RXB (RS-485 mode)	No shorting (RS-422 mode)	OFF	OFF	OFF	ON
9	Changes COM2's communication method	RS-422/RS-485	RS-232C	OFF	OFF	ON	ON
10	Reserved	-	-	-	-	-	-

*1 If you use termination resistance, base your settings on your connection specifications. The COM2 compatible Serial Mode Select Switches (SW4 to SW8) operate as shown in the circuit diagram below.

The COM2 compatible Serial Mode Select Switches (SW4 to SW8) operate as shown in the circuit diagram below.

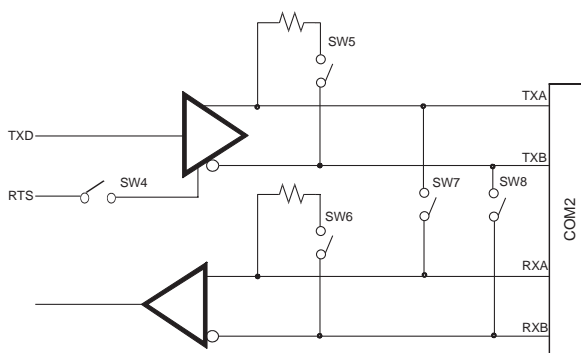

1.4.2 Printer Interface (LPT1)

This interface conforms to Centronics standards.

D-sub 25 pin (Female)

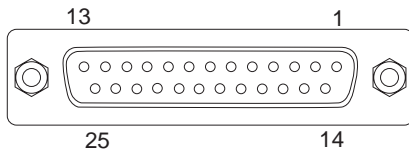

NOTE

- Electrical Specifications

O.D : Open Drain

T.S : 3 state I/O

TTL : TTL Input

Pin No.	SPP/ECP Mode Signal Name	EPP Mode Signal Name	Direction	Electrical Specif.	Pin No.	SPP/ECP Mode Signal Name	EPP Mode Signal Name	Direction	Electrical Specif.
1	STRB	WRITE	In/Output	O.D/T.S ^{*1}	14	AUTOFD	DSTRB	In/Output	O.D/T.S ^{*1}
2	DATA0	DATA0	In/Output	O.D	15	ERROR	ERROR	Input	TTL
3	DATA1	DATA1	In/Output	O.D	16	INIT	INIT	In/Output	O.D/T.S ^{*1}
4	DATA2	DATA2	In/Output	O.D	17	SLCTIN	ADSTRB	In/Output	O.D/T.S ^{*1}
5	DATA3	DATA3	In/Output	O.D	18	GND	GND		
6	DATA4	DATA4	In/Output	O.D	19	GND	GND		
7	DATA5	DATA5	In/Output	O.D	20	GND	GND		
8	DATA6	DATA6	In/Output	O.D	21	GND	GND		
9	DATA7	DATA7	In/Output	O.D	22	GND	GND		
10	ACKNLG	ACKNLG	Input	TTL	23	GND	GND		
11	BUSY	WAIT	Input	TTL	24	GND	GND		
12	PE	PE	Input	TTL	25	GND	GND		
13	SLCT	SLCT	Input	TTL					

*1 Pins 1, 14, 16 and 17 will become O.D when the SPP mode specification is used. If the mode changes to ECP or EPP, these pins will become T.S

1.5 PS-A Unit External Views and Dimensions

1.5.1 PS-A Unit

Unit:mm [in]

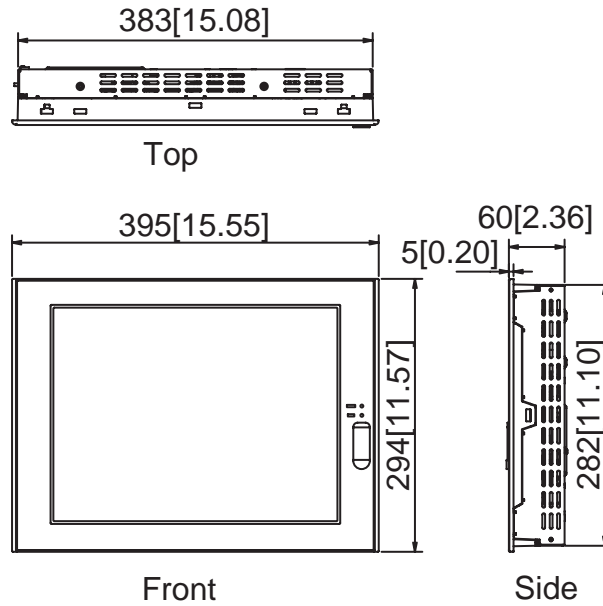

1.5.2 External Dimensions (with Installation Fasteners installed)

Unit:mm [in]

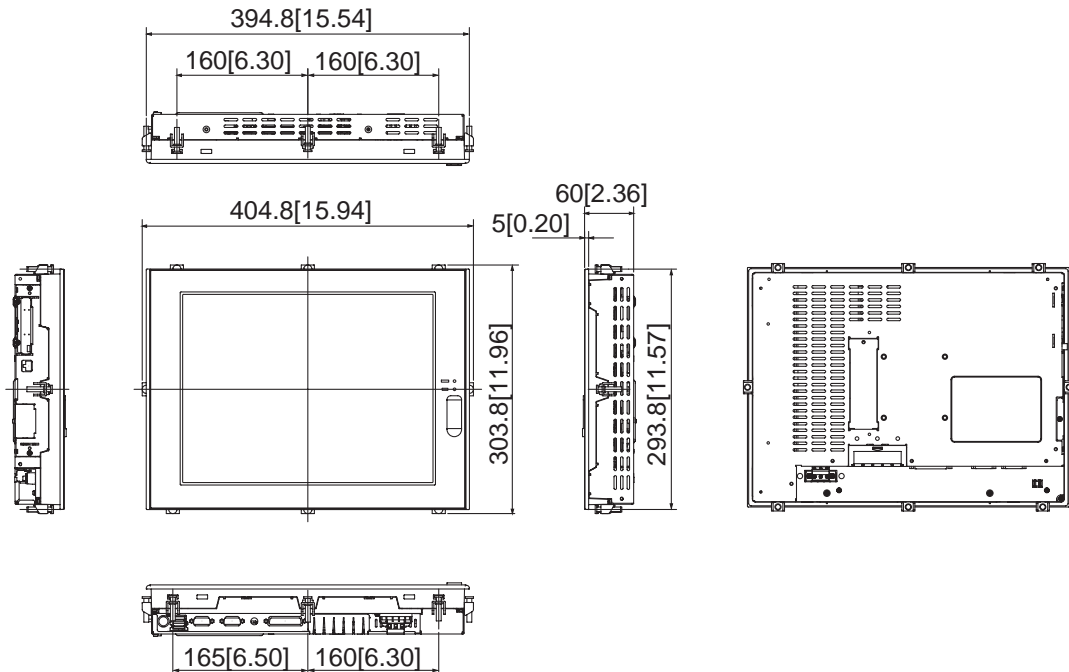

1.5.3 Panel Cut Dimensions

Unit:mm [in]

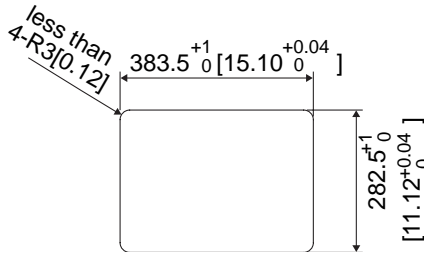

IMPORTANT

- Be sure the thickness of the installation panel is from 1.6 mm [0.06 in] to 10 mm [0.39 in].
- All panel surfaces used should be strengthened. Especially, if high levels of vibration are expected and the PS-A's installation surface (i.e. an operation panel is door, etc.) can move (i.e.open or close) due consideration should be given to the PS-A's weight.
- To insure that the PS-A's water resistance is maintained, be sure to install the PS-A into a panel that is flat and free of scratches or dents.
- Be sure all installation tolerances are maintained to prevent the unit from falling out of its installation panel.

1.5.4 Installation Fasteners

Unit:mm [in]

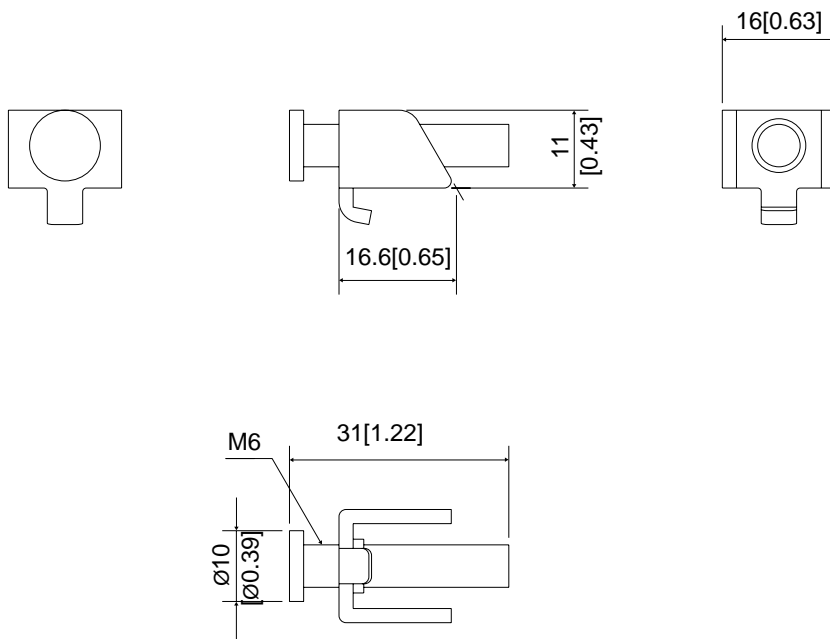

2



Hardware Installation

1. Installation
2. Installing the PS-A Unit
3. Wiring the PS-A

2.1 Installation

A wide variety of optional units, Main Memory, CFcards, PCMCIA (PC cards) manufactured by Digital Electronics Corporation and commercial PCMCIA (PC Cards) can be used with the PS-A. Unscrew the five (8) cover attachment screws, and remove the cover. Install the desired products as shown in the "2.1.2 PS-A Internal View" drawing.

For the detailed optional unit installation procedures, refer to that unit's "Installation Guide".

WARNING

 Be sure to disconnect the power cord from the power supply and confirm that power is not supplied to the PS-A unit before installing any optional units, Main Memory, CF cards. Failure to do so can result in an electric shock.

IMPORTANT

- Use a screwdriver to loosen and tighten the screws. Be sure not to tighten the screws too tightly. Excessive force can damage the equipment.
- When removing or replacing screws, be careful that they do not fall inside the PS-A unit's chassis.

2.1.1 Removing the PS-A Unit's Cover

Lay the PS-A unit on its side and remove the five (8) cover attachment screws. Slide the rear cover up to remove it in the direction shown. (When reattaching the screws, use a torque of 0.5 to 0.6N•m.)

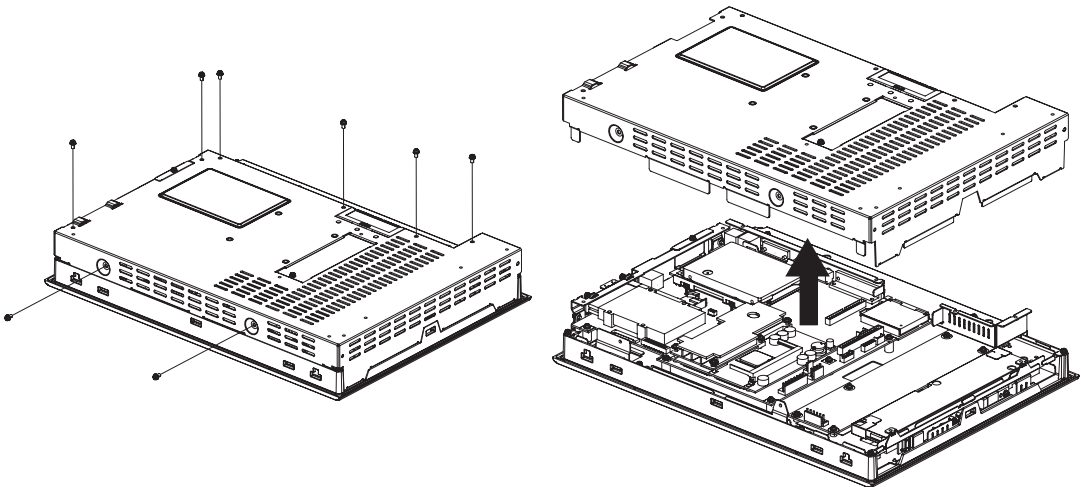

2.1.2 PS-A Internal View

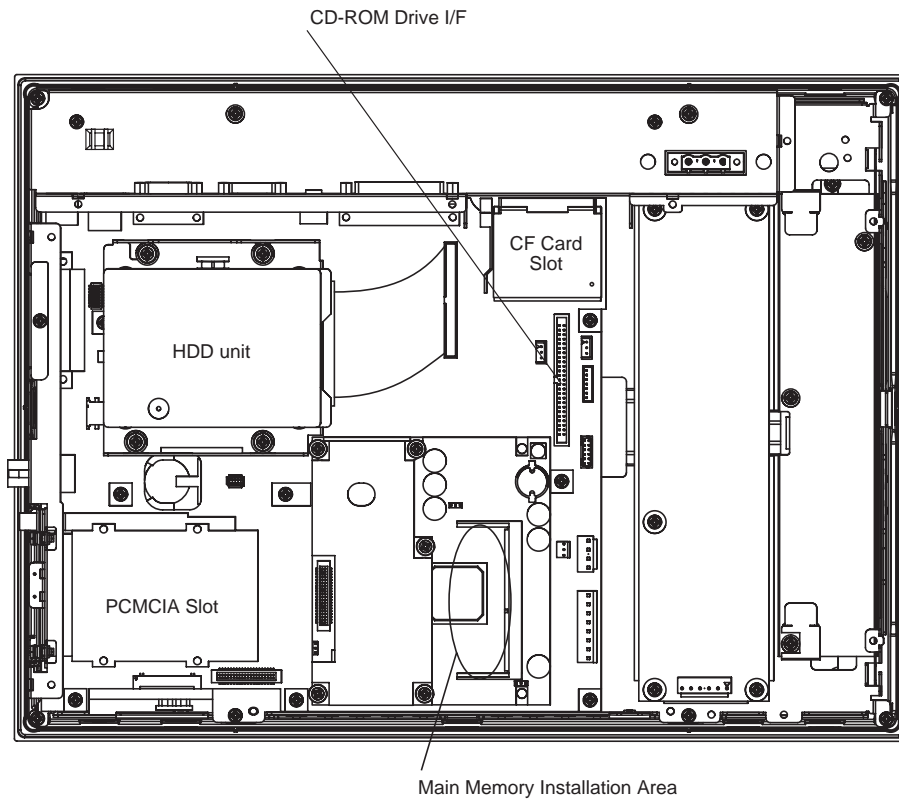

2.1.3 Main Memory Installation

- (1) Remove the PS-A unit's rear cover.

SEE → 2.1.1 Removing the PS-A Unit's Cover (page 2-2)

- (2) Angle the main memory module down slightly, and push it in until the connector pins mate with the module's pins. Then, lower the module until it is horizontal and insert it completely into the connector. This connector is shown in 2.1.2 Main unit internal diagram.

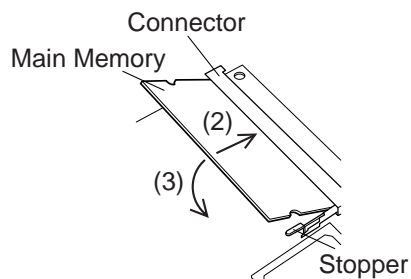

- (3) Push in the main memory module until the stopper snaps into place.

2.1.4 PCMCIA Unit Installation

- (1) Remove the PCMCIA slot cover's screws (2).

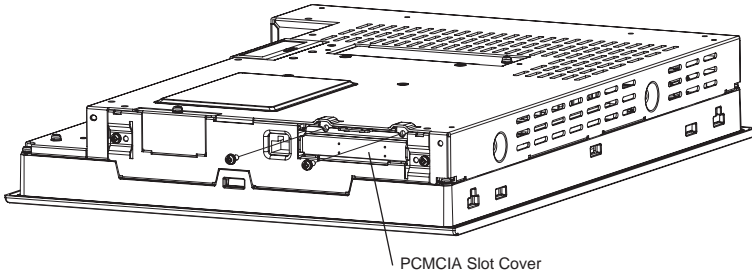

- (2) [Inserting a commercial-type PC Card]

Insert the commercial-type PC Card into the PCMCIA connector.

- NOTE**
- The PCMCIA slot has 2 connectors. When inserting the PCMCIA Card, check carefully that it is connected to the correct connector.

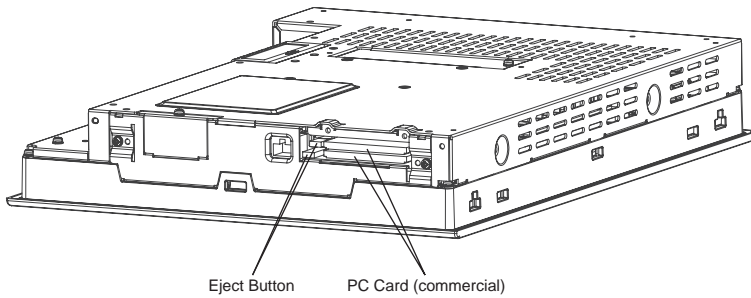

[Removing the PC Card]

Press the eject button twice to remove the PC Card from the PCMCIA connector.

Pressing the eject button once causes its tip to come out.

Pressing the eject button the second ejects the PC Card from the PCMCIA slot.

- (3) Replace the PCMCIA slot cover removed in (1) and secure it in place using the two PCMCIA slot screws. The necessary torque is 0.5N•m to 0.6N•m.

- NOTE**
- When using a PC Card with a cable attached, Pro-face recommends you use a clamp or other type of device to prevent vibration from possibly dislodging the cable.
 - Be sure to stop the PS-A unit PC Card's driver prior to removing the PC Card. A failure to stop this driver may result in damage to either the PC Card, the PC Card's data, or may cause Window³ to hang up. For information on the procedure for stopping the PC Card's driver, please refer to your OS User Manual.

2.1.5 USB Cable Clamp Installation

This holder prevents the USB cable from becoming disconnected due to vibration, etc.

- (1) Place the PS-A unit face-down on a flat surface as shown below. Your PS-A unit has two USB interfaces.

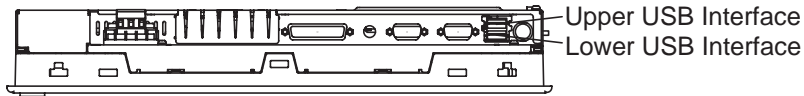

NOTE

- When using both USB connectors, be sure to first connect one USB cable to the lower USB interface, then connect the second USB cable to the upper USB interface.
- When using only one of the USB ports, be sure to use the lower USB connector. This allows you to securely clamp the USB cable in the cable clamp.

■ Attachment

As shown below, insert the USB Cable Clamp's band through the Bridge. Pass the USB cables through the Cable Clamp's band and securely tighten the clamp band around the cables.

NOTE

- Be sure the clamp is securely holding the USB cable's plug and collar.
- Be sure the clamp is positioned as shown below, with the clamp pointing upwards - not to the side. This is to keep the clamp from interfering with nearby connectors and their cables.

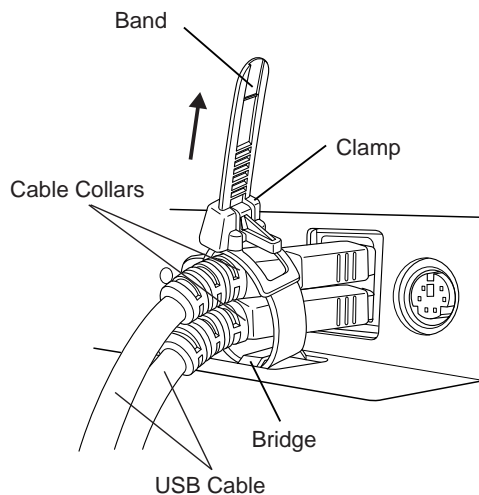

■ Removal

To remove the clamp from the USB cables, push down on the clamp strap's clip to release it while pulling up on the clamp.

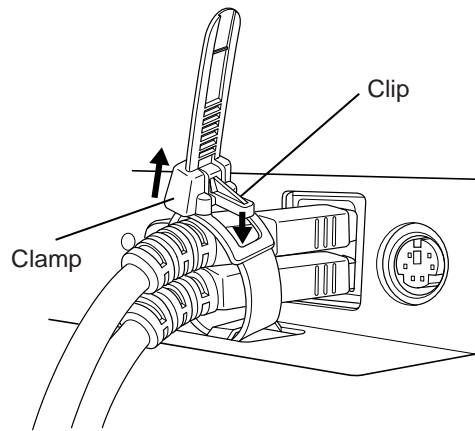

2.1.6 CF Card Installation and Removal

CAUTION

■ When using the PS-A Unit and a CF Card, follow the precautions below:

- ❗ Be sure to use only CF Cards manufactured by the Digital Electronics Corporation. PS-A unit performance cannot be guaranteed when using another manufacturer's CF Card.
- ❗ Be sure to follow the instructions given below to prevent the CF Card's internal data from being destroyed or a CF Card malfunction from occurring:
 - DO NOT bend the CF Card.
 - DO NOT drop or strike the CF Card against another object.
 - Keep the CF Card dry.
 - DO NOT touch the CF Card connectors.
 - DO NOT disassemble or modify the CF Card.

■ When using the CF Card Unit and the CF Card

- ❗ Prior to inserting the CF Card, be sure to confirm that the rear and the front of the CF Card are correctly oriented, and that the CF Card connector position is correct. If the CF Card is inserted incorrectly, the CF Card, its internal data, and the CF card unit may be damaged.
- ❗ Since the PS-A unit's OS views the CF Card as a hard disk, do not remove or insert the CF Card when the unit's power is switched ON. Doing so may damage data and stop OS operation. Be sure to shut down the OS and switch power OFF prior to removing or inserting a CF Card.
- ❗ Never turn OFF or reset the PS-A while accessing the CF Card to prevent damaging file data. Also, be sure to shut down the PS-A unit's OS before turning OFF the main power.

■ Data Overwrite Limit

The CF Card has a data overwrite limit of approximately 100,000 times. Therefore, be sure to back up all CF Card data regularly to another storage media. (100,000 times assumes the overwriting of 500KB of data in DOS format)

■ A CF Card Insertion and Removal

Familiarize yourself with the differences between the top and bottom surfaces of the CF Card. Also, be sure to read the CF Card's installation guide to ensure that the Card is properly oriented when it is inserted (i.e. whether the top of the card is up or down etc.)

■When inserting the CF Card

- (1) Slide the CF Card cover in the direction shown and open the CF Card cover.

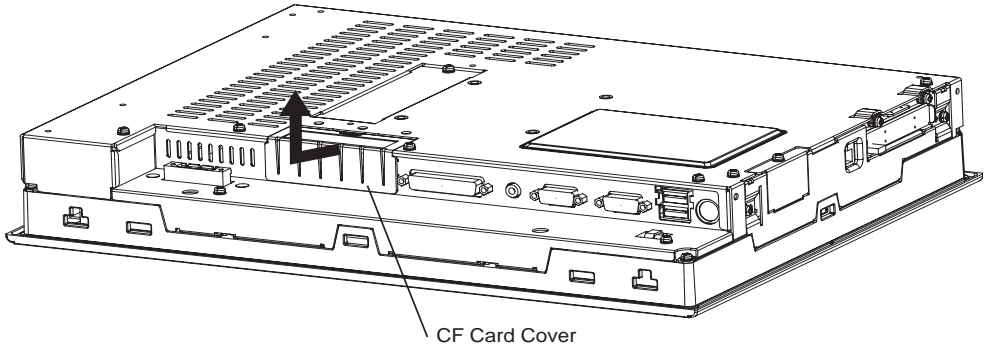

- (2) Insert the CF Card firmly into the CF card slot, and check that the eject button pops out.

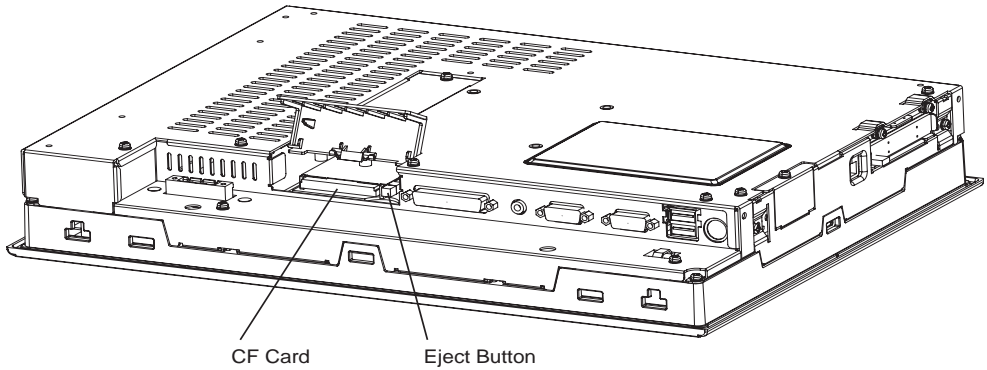

■Removing the CF Card

- (3) Press the eject button in fully to remove the CF Card from the CF Card slot.
- (4) After inserting/removing the CF card, be sure to replace the CF Card cover and secure it in place using the attachment screw.

IMPORTANT

- The necessary torque is 0.5N•m to 0.6N•m.

2.2 Installing the PS-A Unit

2.2.1 Installation Caution

■ Temperature Related Cautions

- The PS-A should be installed in a vertical position and natural air cooling.
- Check the ambient temperature at the positions shown in the illustrations below. Temperatures exceeding the proper ambient temperature (When using HDD: +5 to +40°C, When not using HDD: +0 to +40°C) may lead to product breakdown.

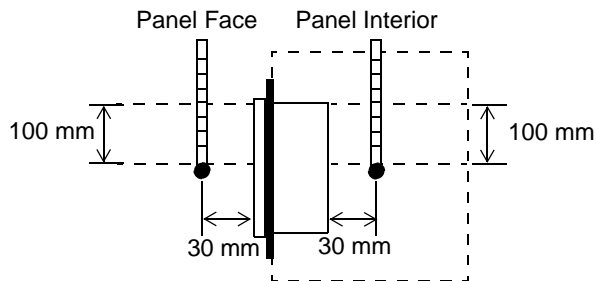

■ Installation Positioning Cautions

Be sure to install the panel in an upright (vertical) position.

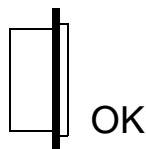

Vertical

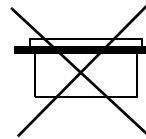

Horizontal

Also, be sure that the panel's viewing angle is tilted no more than 30 degrees from parallel to the operator (i.e. directly in front).

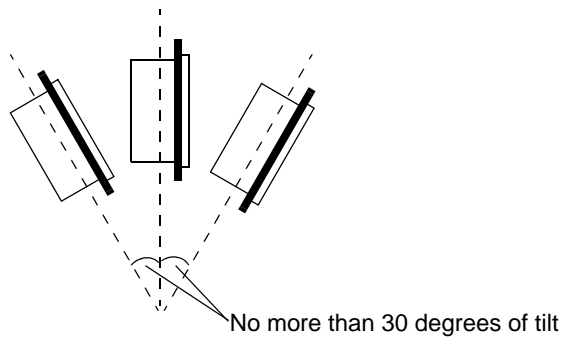

■ Installation Location

- Avoid placing the PS-A next to other devices that might cause overheating.
- Keep the PS-A away from arc-generating devices such as magnetic switches and non-fuse breakers.
- Avoid using the PS-A in environments where corrosive gases are present.
- To ensure the reliability, operability and ventilation of the PS-A, be sure to install it in locations that are more than 100mm away from adjacent structures or equipment. Also, consider the need for installing, or connectors when designing and installing your PS-A.

Unit: mm [in]

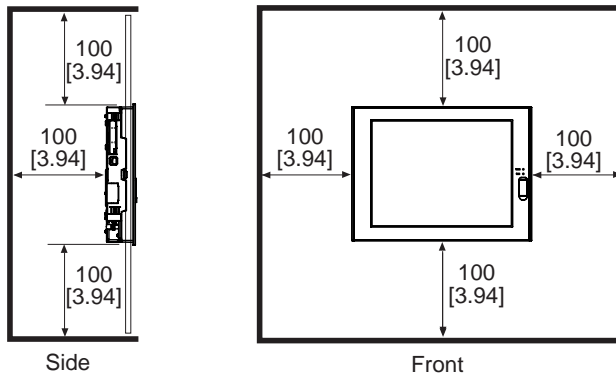

■ Vibration and Shocks

If the PS-A is moved when its enclosure doors are open, or while it is installed in a rack equipped with caster wheels or when using a stand with an arm attached or when attached to a wall, the hard disk can receive excessive vibration or jolting. Be especially careful at this time.

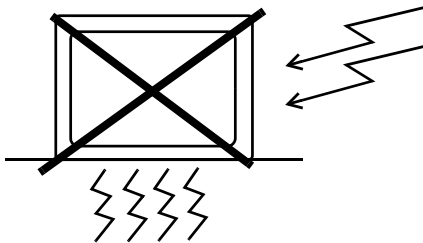

PS-A Unit	Shock Resistance
When using the HDD	Up to 4.9m/s ²
When not using the HDD	Up to 19.6m/s ²

IMPORTANT

- Be sure not to move the PS-A unit while the HDD is starting up. This can lead to a machine breakdown (Even a slight movement of the PS-A should not be performed).
- When using a fan to cool the PS-A unit, be sure that the fan does not point directly at any of the PS-A's disk drive units.

2.2.2 Installation Procedures

Follow the steps given below when installing the PS-A.

■ Attaching the Installation Gasket

Even if the your PS-A's Installation Gasket is not needed to prevent water from entering the unit, the gasket also acts as a vibration absorber and should always be attached. To install it, place the PS-A face down on a soft surface and attach the gasket to the rear side of the display face, in the plastic bezel's groove (see picture below).

IMPORTANT

- Before mounting the PS-A into a cabinet or panel, check that the installation gasket is attached to the unit.
- A gasket which has been used for a long period of time may be scratched or dirty, and may have lost much of its water resistance. Be sure to change the gasket at least once a year, or when scratches or dirt become visible.
- The corresponding gasket is CA3-WPG15-01.
- Since the gasket is flexible but not elastic, be careful not to stretch it unnecessarily, as doing so could tear the gasket.
- Be sure, when pushing the gasket into the installation groove and around the corners of the PS-A, that the gasket's seam is not placed in a corner. Placing the seam here could eventually cause the gasket to tear
- Be sure to place the gasket's flat, non-grooved side facing down.

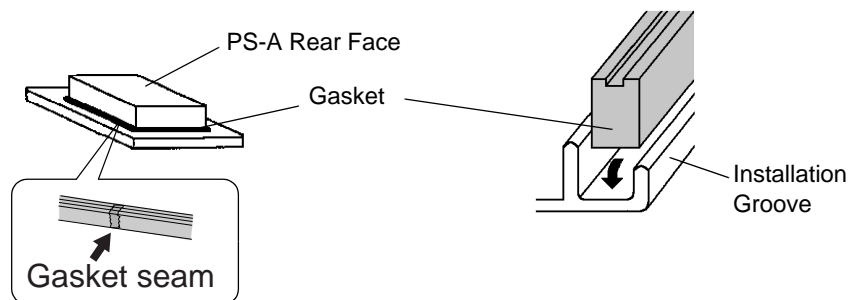

IMPORTANT

- If the installation gasket is not properly inserted into the groove, the gasket's moisture resistance may not be equivalent to IP65f.
- When the installation gasket is properly inserted, approximately 2.0 mm of it will extend outside the groove. Before installing a PS-A into a panel, be sure to confirm that the gasket is correctly in place.

■ Create a Panel Cut

Create a panel cut for the PS-A, like that pictured here. Two additional items, the installation gasket and the installation fasteners are required when installing the PS-A.

SEE → 1.5.3 Panel Cut Dimensions (page 1-14)

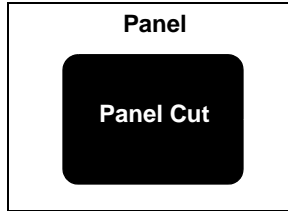

NOTE

- To obtain the maximum degree of moisture resistance, be sure to install the PS-A on a smooth, flat surface.
- The panel itself can be from 1.6 mm [0.06 in] to 10.0 mm [0.39 in] thick

IMPORTANT

- Strengthening may be required for the panel. Be sure to consider the weight of the PS-A when designing the panel.

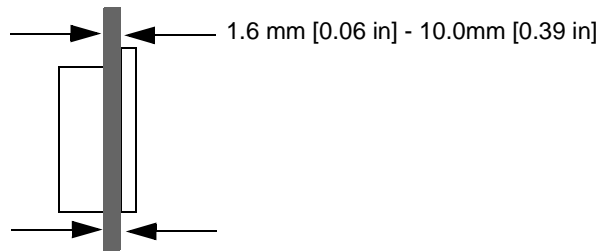

■ PS-A Viewing Angle

- Be sure that the panel's viewing angle is tilted no more than 30 degrees from parallel to the operator (i.e. operator is directly in front).

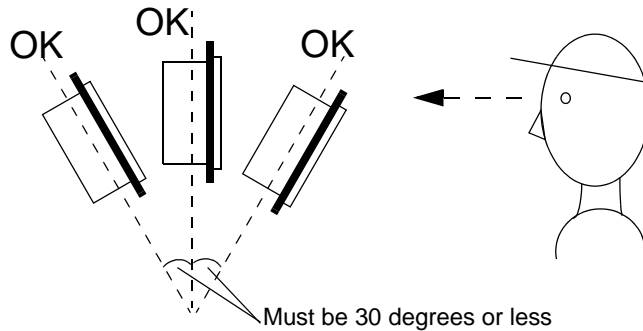

- Avoid placing the PS-A next to other devices that might cause overheating.
- Avoid using the PS-A where the ambient temperature will be higher than the allowed specification.
- Keep the PS-A away from arc-generating devices such as magnetic switches and non-fuse breakers.
- Avoid using the PS-A in environments where corrosive gases are present.

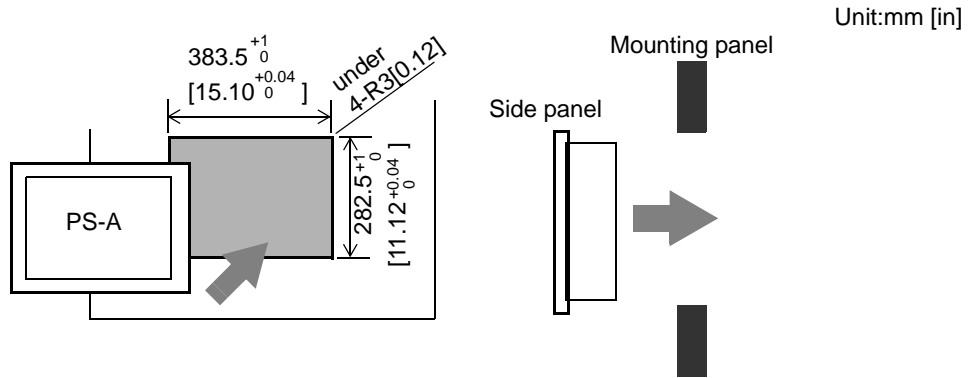
■ Insert the PS-A into the installation slot**IMPORTANT**

- Be sure the panel cut's actual measurements are the same as those given here, otherwise the PS-A may slip or fall out of the panel.

■ Attach and Secure the Rear Installation Fasteners

(1) Locate the PS-A's attachment holes, located on the top, bottom, and sides of the PS-A.

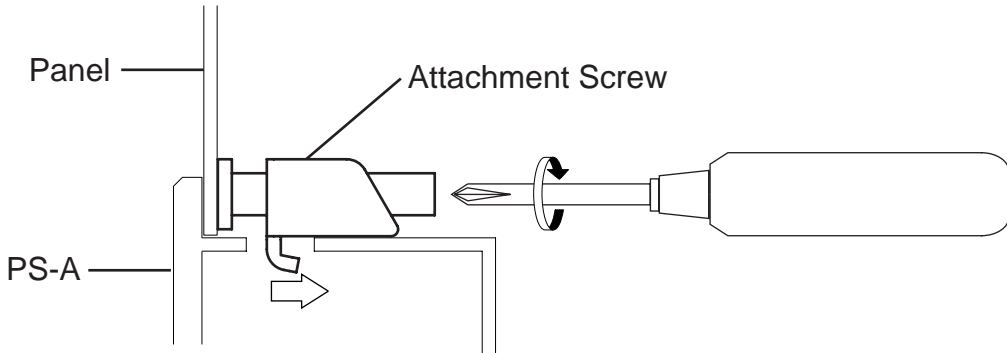
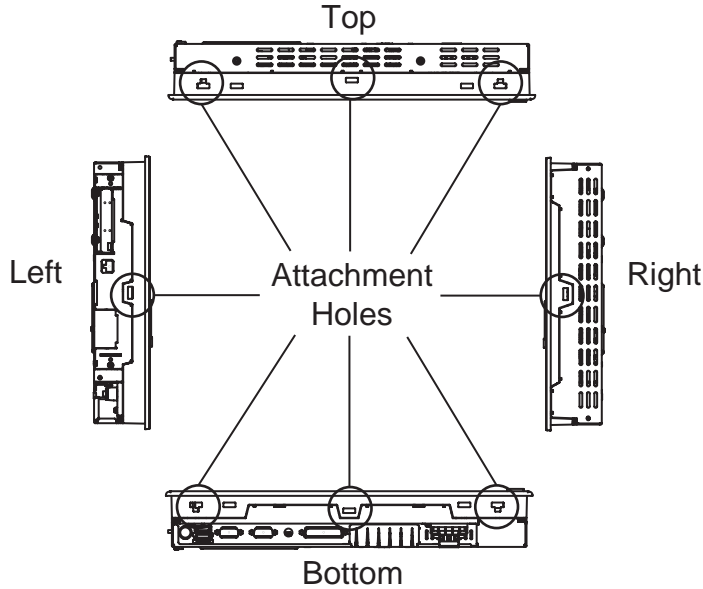

- IMPORTANT**
- Excessive torque may damage the PS-A unit.
 - To ensure a high degree of moisture resistance, the torque should be 0.5N•m.

- NOTE**
- Depending on the installation panel's thickness, etc., the number of installation fasteners used may need to be increased to provide the desired level of moisture resistance.
 - The corresponding installation fasteners are CA3-ATFALL-01.

2.3 Wiring the PS-A

2.3.1 Connecting the Power Cord

Insert the power cord into the PS-A's bottom face Power Input Terminal Block.

⚠ WARNING

- ❗ To avoid an electric shock, check that the PS-A's power supply is turned OFF, via a breaker, or similar unit before connecting the PS-A's power cord to the Power Input Terminal Block.
- ❗ To avoid the dangers of fire, electric hazards and equipment damage, be sure to use only the specified voltage when operating the PS-A.
- ❗ Since the PS-A unit has no power ON/OFF switch, be sure to attach a breaker-type switch to its power cord.

IMPORTANT

- When the FG terminal is connected, be sure the wire is grounded.
Not grounding the PS-A unit will result in excess noise and vibration.

NOTE

- Whenever possible, use thick wire (max. 2mm²) for PS-A power cord power terminals. Also, to reduce noise be sure to twist the wire ends.

■ Attaching the Power Cord

When connecting the power code, be sure to follow the procedures given below.

- (1) Confirm that the PS-A power code is unplugged from the power supply.
- (2) Loosen the screws from the middle three (3) terminals.
- (3) Remove the wire's external covering and insert the wire center stand into the opening.
- (4) Re-attach the screws.

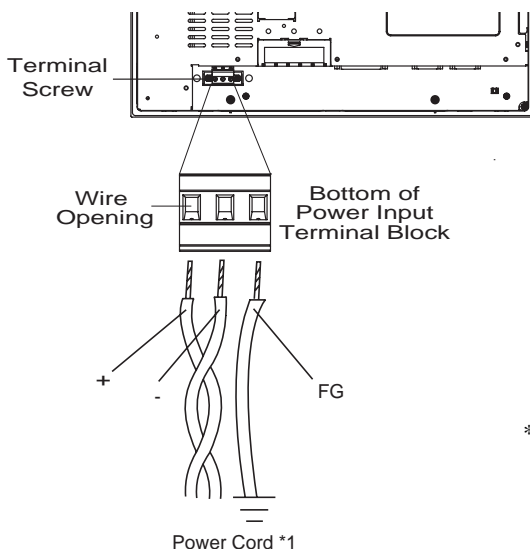

*1 + : Positive electrode

- : Negative electrode

FG : Ground Terminal connected to the PS-A chassis

NOTE

- The torque required to tighten these screw is 0.5 to 0.6N•m.
- Do not solder the wire itself.
- If the central wire's end strands are not twisted correctly, the end strands may either short against each other, or against an electrode.

2.3.2 Power Supply Cautions

When connecting the PS-A unit's Power Input Terminal Block, please be aware of the following:

- If voltage fluctuations are expected to vary beyond the specified range, connect a constant voltage transformer.

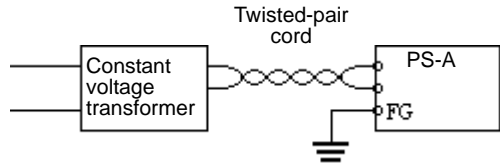

SEE → For information about the specified voltage, refer to 7.1 General Specifications (page 7-2)

- Use a low-noise power supply both between the lines and between the PS-A and its ground. If there is still excess noise, connect an insulating transformer (noise-prevention type).

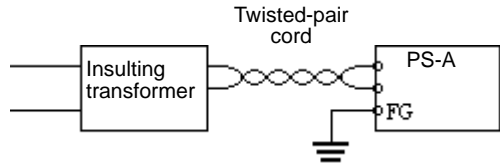

NOTE • Be sure any constant or insulating transformer used has a capacity of 200VA or more.

- Wire the power cords of the PS-A, I/O devices, and power supply devices separately.

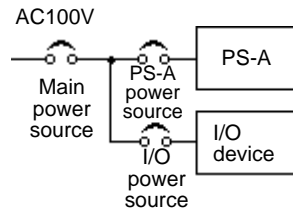

- To improve noise immunity, it is recommended to attach a ferrite core to the power cord.
- Isolate the main circuit (high voltage, large current) line, I/O signal lines, and power cord, and do not bind or group them together.

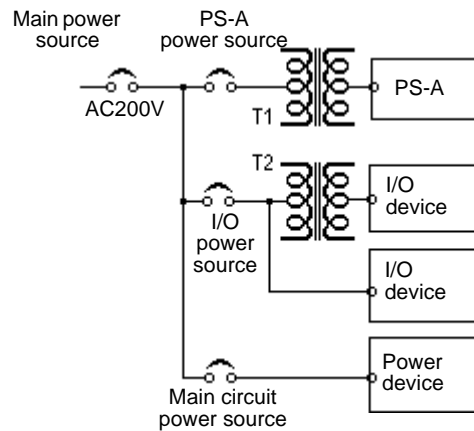

- To prevent damage from lightning, connect a lightning surge absorber.

IMPORTANT

- Ground the lightning surge absorber (E1) and the PS-A (E2) separately.
- Select a lightning surge absorber which will not exceed the allowable circuit voltage, even when the voltage rises to the maximum.

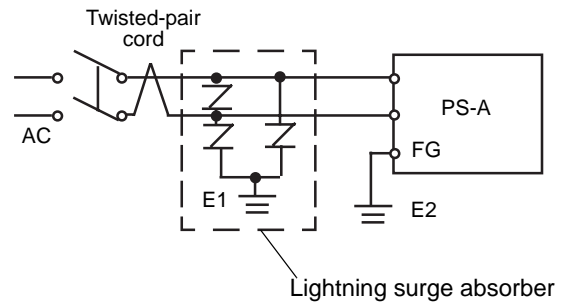

2.3.3 Grounding Cautions

(a) Dedicated Ground *1

- Set up a dedicated ground when using the rear panel's FG terminal.

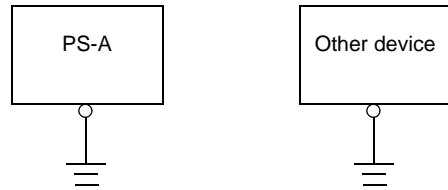

(b) Shared Ground - allowed *1

- If a dedicated ground is not possible, use a shared ground, as shown in figure.
- Inside the PS-A unit, the SG (Signal Ground) and FG (Frame Ground) terminals are connected to each other.

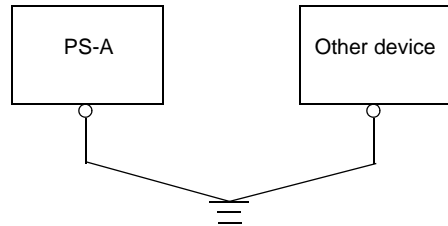

(c) Shared ground - not allowed

- When connecting an external device to PS-A with the SG terminal, ensure that no short-circuit loop is created when you set up the system.
- The grounding point must be as close to the PS-A as possible, and the grounding wires must be as short as possible. If the wires must be long, use thick, insulated wires and run them through conduits.

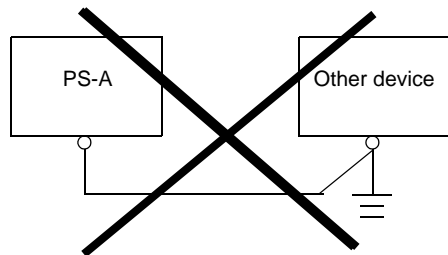

2.3.4 Cautions When Connecting I/O Signal Lines

- I/O signal lines must be wired separately from the power circuit cable. If the power circuit cable needs to be wired together with the input/output (I/O) signal lines for any reason, use shielded cables and ground one end of the shield to the PS-A's FG terminal.
- To improve noise immunity, it is recommended to attach a ferrite core to the power cord.

*1 Use a grounding resistance of 100Ω or less, and a 2 mm² or thicker wire, or your country's applicable standard. For details, contact your local PS-A distributor.

3



System Setup

1. Setup Procedures
2. System Parameters

3.1 Setup Procedures

IMPORTANT

- Normally, use only the factory (default) settings.

NOTE

- The following settings are those pre-set at the factory.

- (1) Connect a keyboard to the PS-A.
- (2) Turn the PS-A's power ON.
- (3) After the message "Press to Enter SETUP" appears, press the [DEL] key until the following screen appears.

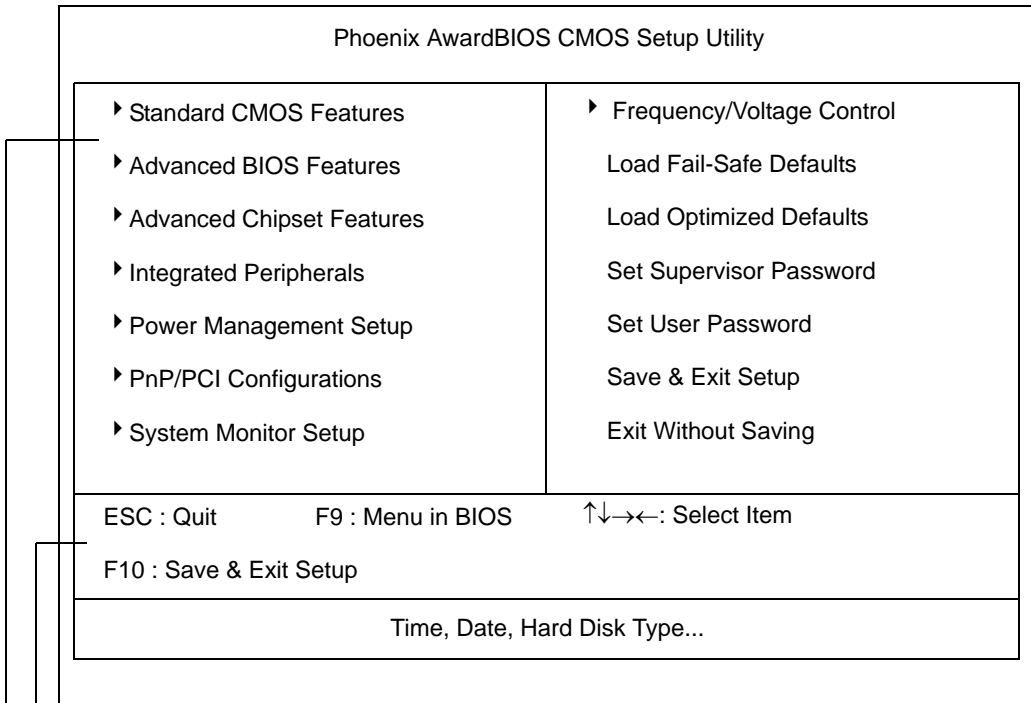

KEYBOARD ACTION KEYS

Provides a summary of the keyboard keys used to carry out the set up.

SYSTEM SETTING SELECTION AREA

Each of the titles (areas) listed here contains system setting items.

- (4) Use the arrow keys to move the cursor to the desired selection.

3.2 System Parameters

3.2.1 Standard CMOS Features

- IMPORTANT** • Normally, use only the factory (default) settings.

Selecting the STANDARD CMOS FEATURES menu item produces the following screen.

Phoenix AwardBIOS CMOS Setup Utility		
Standard CMOS Features		
Date (mm:dd:yy):	Wed,Jun 25 2003	Item Help
Time (hh:mm:ss):	14 : 50 : 3	
▶ IDE Primary Master	[None]	Menu Level ▶ Change the day, month, year and century
▶ IDE Primary Slave	[None]	
▶ IDE Secondary Master	[None]	
▶ IDE Secondary Slave	[None]	
Drive A	[None]	
Video	[EGA/VGA]	
Halt On	[All,But Keyboard]	
Base Memory	640K	
Extended Memory	11366K	
Total Memory	114688K	
↑↓→←: Move Enter: Select +/-/PU/PD: Value F10: Save ESC: Exit F1: General Help F5: Previous Values F6: Fail-Safe Defaults F7: Optimized Defaults		

■ Date (mm:dd:yy)

The PS-A unit's internal calendar and clock allow you to set the date. The day of the week is automatically set.

Month: Jan/Feb/Mar/Apr/May/June/Jul/Aug/Sep/Oct/Nov/Dec

Day: 1 to 31

Year: 1999 to 2099

■ Time (hh:mm:ss)

The PS-A unit's internal clock can be set. The hh/mm/ss (0:0:0) format is factory set prior to shipping.

Hours: 0 to 23

Minutes: 0 to 59

Seconds: 0 to 59

■IDE Primary (Secondary) Master (Slave)

Displays the name of the IDE type Hard Disk connected to the PS-A. Pressing the [Enter] key will call up the Parameter settings menu. For details,

SEE → 3.2.2 IDE HDD Auto-Detection (page 3-5)

■Drive A

This setting determines the format used by the PS-A's internal floppy disk drive. The available settings are [None], [360K - 5.25in], [720K - 3.5in], [1.2M - 5.25in] , [1.44M - 3.5in], or [2.88M, 3.5in].

The factory setting is [None] , and recommended for most users.

■Video

The selections for the screen (video) mode. The available settings are [EGA/VGA], [CGA40], [CGA80] and [MONO]. The [EGA/VGA] selection is factory set and recommended for most users.

■Halt On

Designates the type of processing that will be performed when an error occurs during the Initial Start-Up's Self Test. The [All But Keyboard] selection is factory set and recommended for most users.

- | | |
|--------------------|--|
| [All Errors] | : Displays all errors and stops the unit. |
| [No Errors] | : Displays all errors and does not stop the unit. |
| [All,But Keyboard] | : Displays all errors, except for those related to the keyboard, and stops the unit. |
| [All,But Diskette] | : Displays all errors, except for those related to the disk drive (FDD), and stops the unit. |
| [All,But Disk/Key] | : Displays all errors, except for those related to the disk drive (FDD) and keyboard, and then stops the unit. |

3.2.2 IDE HDD Auto-Detection

Selecting either [IDE Primary (Secondary) Master] or [IDE Primary (Secondary) Slave] will call up the following menu. The following example uses the [IDE Primary Master] setting.

Phoenix AwardBIOS CMOS Setup Utility		
IDE Primary Master		
IDE HDD Auto-Detection	[Press Enter]	Item Help
IDE Primary Master	[Auto]	Menu Level ▶▶
Access Mode	[Auto]	To auto-detect the HDD's size, head... on this channel
Capacity		
Cylinder		
Head		
Precomp		
Landing Zone		
Sector		
↑↓→←: Move Enter: Select +/-/PU/PD: Value F10: Save ESC: Exit F1: General Help F5: Previous Values F6: Fail-Safe Defaults F7: Optimized Defaults		

■IDE HDD Auto-Detection

This setting detects the hard disk connected to the IDE interface.

■IDE Primary (Secondary) Master (Slave)

This setting designates the IDE type Hard Disk's parameter setting method. The available settings are [None], [Auto], or [Manual]. The factory default setting is [Auto] and is recommended for most users.

■Access Mode

This setting designates the IDE type Hard Disk's access mode. The available settings are [CHS], [LBA], [Large], or [Auto]. The factory default setting is [Auto] and is recommended for most users.

■Capacity/Cylinder/Head/Precomp/Landing Zone/Sector

These settings designate individual IDE-type Hard Disk parameter settings. When the [IDE Primary (Secondary) Master (Slave)] setting is set to [Manual], the Access Mode must be [CHS]. When the [IDE Primary (Secondary) Master (Slave)] setting is set to [Auto], these values are automatically detected. [Capacity] is set automatically.

3.2.3 Advanced BIOS Features

Selecting the ADVANCED BIOS FEATURES menu item calls up the following screen.

Phoenix AwardBIOS CMOS Setup Utility		
Advanced BIOS Features		
		Item Help
Virus Warning	[Disabled]	Menu Level ▶ Allows you to choose the VIRUS warning feature for IDE Hard Disk boot sector protection. If this function is enabled and someone attempts to write data into this area, BIOS will show a warning message on screen and alarm will beep
CPU Internal Cache	[Enabled]	
External Cache	[Enabled]	
CPU L2 Cache ECC Checking	[Enabled]	
Quick Power On Self Test	[Enabled]	
First Boot Device	[HDD-0]	
Second Boot Device	[CDROM]	
Third Boot Device	[Disabled]	
Boot Other Device	[Disabled]	
Boot Up Floppy Seek	[Disabled]	
Boot Up NumLock Status	[On]	
Gate A20 Option	[Fast]	
Typematic Rate Setting	[Disabled]	
x Typematic Rate(Chars/Sec)	[6]	
x Typematic Delay (Msec)	[250]	
Security Option	[Setup]	
OS Select For DRAM > 64MB	[Non-OS2]	
Video Shadow	[Enabled]	
C8000-CBFFF Shadow	[Disabled]	
CC000-CFFFF Shadow	[Disabled]	
D0000-D3FFF Shadow	[Disabled]	
D4000-D7FFF Shadow	[Disabled]	
D8000-DBFFF Shadow	[Disabled]	
DC000-DFFFF Shadow	[Disabled]	
Small Logo (EPA) Show	[Disabled]	
↑↓→←: Move Enter: Select +/-/PU/PD: Value F10: Save ESC: Exit F1: General Help F5: Previous Values F6: Fail-Safe Defaults F7: Optimized Defaults		

■Virus Warning

This setting determines whether to display a warning when a write to the HDD's start-up sector is attempted.

The available settings are [Enabled] or [Disabled]. The factory default setting is [Disabled] and is recommended for most users.

■CPU Internal Cache

Designates if CPU L1 Cache Memory usage is enabled or disabled. Selections are [Disabled] and [Enabled].

The factory setting is [Enabled].

■External Cache

Designates if CPU L2 Cache Memory usage is enabled or disabled. Selections are [Disabled] and [Enabled].

The factory setting is [Enabled].

■CPU L2 Cache ECC Checking

Designates if CPU L2 Cache Memory's ECC check is to be performed or not. Selections are [Disabled] and [Enabled]. The factory setting is [Enabled].

■ Quick Power On Self Test

This setting determines whether the quick self test is performed when the power is turned on. The available settings are [Disabled] or [Enabled]. The factory default setting is [Enabled] and is recommended for most users.

■ First/ Second/ Third Boot Device

The selections for the search drive sequence of the operating system. The available settings are [Floppy], [HDD-0], [SCSI], [CDROM], [HDD-1], [HDD-2], [HDD-3], [USB-FDD], [USB-ZIP], [USB-CDROM], [USB-HDD], [LAN], and [Disabled]. Factory settings are: First: [HDD-0], Second:[CDROM], Third: [Disabled].

■ Boot Up Other Device

The selections for the search the other drive sequence of the operating system. The available settings are [Enabled]or[Disabled]. Factory setting is [Disabled].

■ Boot Up Floppy Seek

The setting checks whether the floppy disk drive is installed during the system boot-up process.

The available settings are [Disabled] or [Enabled]. The factory default setting is [Disabled] and is recommended for most users.

■ Boot Up NumLock Status

This setting specifies the NumLock key status upon the startup. The available settings are [On] and [Off]. The factory default setting is [On] and is recommended for most users.

■ Gate A20 Option

Designates the access speed used when accessing 1MB or more of memory. Select [Fast] (Enables fast memory access - allows chipset to handle Gate A20) or [Normal] (Standard method - Windows compatible PC uses the keyboard controller for access). The factory setting is [Fast].

■ Typematic Rate Setting

The setting specifies the keyboard speed used when repeating characters. The available settings are [Enabled] and [Disabled]. The factory default setting is [Disabled] and is recommended for most users.

■ Typematic Rate (Chars/Sec)

This setting specifies the actual typematic rate (repeated character input per second) when the [Typematic Rate Setting] option is set to [Enabled]. The settings are used to determine how many repeats are performed in one second. The factory default setting is [6] and is recommended for most users.

■ Typematic Delay (Msec)

When [Typematic Rate Setting] is set to [Enabled], this setting determines the delay period until the initial repetition is started. The [250] selection is factory set and is recommended for most users.

■ Security Option

This setting designates the area to request a password. If a password needs to be entered, select [Setup] in BIOS setup, or [System] during system startup. This setting is NOT available if the password is not set in the [SET SUPERVISOR PASSWORD] or [SET USER PASSWORD] areas. The factory default setting is [Setup] and is recommended for most users.

[SET SUPERVISOR PASSWORD]

SEE → 3.2.13 Set Supervisor Password (page 3-22)

[SET USER PASSWORD]

SEE → 3.2.14 Set User Password (page 3-22)

■ OS Select For DRAM > 64MB

The available settings are [Non-OS2] and [OS2]. The factory default setting is [Non-OS2] and is recommended for most users.

■ Video BIOS Shadow

Designates if VIDEO BIOS's BIOS is copied from ROM to RAM. The factory setting is [Enabled].

■ Small Logo (EPA) Show

Enables/disables the initial display at startup of the EPA logo. The available selections are [Enabled] and [Disabled], [Disabled] is factory set and recommended for most users.

3.2.4 Advanced Chipset Features

Selecting the ADVANCED CHIPSET FEATURES menu item calls up the following screen.

Phoenix AwardBIOS CMOS Setup Utility		
Advanced Chipset Features		
		Item Help
DRAM Timing by SPD	[Disabled]	Menu Level ▶
Memory Hole	[Disabled]	
P2C/C2P Concurrency	[Enabled]	
System BIOS Cacheable	[Disabled]	
Video BIOS Cacheable	[Disabled]	
Frame Buffer Size	[16M]	
AGP-4X Mode	[Enabled]	
AGP Graphics Aperture Size	[64MB]	
AGP Driving Control	[Auto]	
OnChip USB	[Enabled]	
USB Keyboard Support	[Disabled]	
OnChip Sound	[Auto]	
CPU to PCI Write Buffer	[Enabled]	
PCI Dynamic Bursting	[Enabled]	
PCI Master O WS Write	[Enabled]	
PCI Delay Transaction	[Disabled]	
PCI #2 Access #1 Retry	[Disabled]	
AGP Master 1 WS Write	[Disabled]	
AGP Master 1 WS Read	[Disabled]	
↑↓→←: Move Enter: Select +/-/PU/PD: Value F10: Save ESC: Exit F1: General Help F5: Previous Values F6: Fail-Safe Defaults F7: Optimized Defaults		

■ DRAM Timing by SPD

Designates the DRAM Timing settings manually or automatically (SPD: Serial Presence Detect).

Settings available are [Enabled (automatically)] and [Disabled (manually)], the factory default setting is [Disabled] and strongly recommended for most users.

■ Memory Hole

Reserves memory area for the ISA card and improves performance.

Available selections are [Enabled] and [Disabled]. The factory setting is [Disabled].

■ P2C/C2P Concurrency

Allows simultaneous transfer of data from a PCI card to the CPU and from the CPU to the PCI card. Available selections are [Enabled] and [Disabled]. The factory setting is [Enabled].

■ System BIOS Cacheable

Sets whether the System BIOS Cache is used or not. When the OS is set to use this cache, the PS-A unit's processing speed will increase. Settings available are [Enabled] and [Disabled]. The factory setting is [Disabled] and is recommended for most users.

■ Video BIOS Cacheable

Sets whether the Video BIOS Cache is used or not. Settings available are [Enabled] and [Disabled]. The factory setting is [Disabled]. When this feature is [Enabled], the BIOS ROM range available for caching is from C0000h - F7FFFh, which will improve video performance. However, if another program tries to write to this area of memory, a system error may occur.

■ Frame Buffer Size

This feature set the Memory Range for built-in-VGA. The available selections are [2M]or[4M]or[8M]or[16M]or[32M]. The factory setting is [16M].

■ AGP Graphics Aperture Size

Designates the address range used for PCI memory addresses allocated to AGP graphic memory. The available settings are [4MB], [8MB], [16MB], [32MB], [64MB], [128MB] or [256MB]. [64MB] is the factory setting.

■ AGP Driving Control

Designates if AGP Drive Control is used.

Available selections are [Auto] and [Manual]. The factory setting is [Auto].

■ AGP-4X Mode

This feature enables/disables the AGP-4X Mode feature.

The available selections are [Enabled] and [Disabled]. The factory setting is [Enabled].

■ OnChip USB

Designates if the OnChip USB is used.

Available selections are [Enabled] and [Disabled]. The factory setting is [Enabled].

■ USB Keyboard Support

Designates if the USB Keyboard is used.

Available selections are [Enabled] and [Disabled]. The factory setting is [Enabled].

■ OnChip Sound

Designates if the OnChip Sound is used.

Available selections are [Auto] and [Disabled]. The factory setting is [Auto].

■ CPU to PCI Write Buffer

Designates if the Write Buffer between the CPU and the PCI board is to be enabled or not.

Available selections are [Enabled] and [Disabled]. The factory setting is [Enabled].

■ PCI Dynamic Bursting

Selecting [Enabled] temporarily saves data to the PCI Write Buffer. Selecting [Disabled] sends data directly to the PCI bus. Available selections are [Enabled] and [Disabled]. The factory setting is [Enabled].

■ PCI Master O WS Write

Designates the wait time used when writing data to the PCI board.

Available selections are [Enabled] and [Disabled]. Selecting [Enabled] means there is no wait time.

The factory setting is [Enabled].

■ PCI Delay Transaction

Controls the transaction delay function.

Available selections are [Enabled] and [Disabled]. The factory setting is [Disabled].

■ PCI #2 Access #1 Retry

During AGP (PCI #2) Master Retry, designates if the AGP is to be disconnected or not.

Available selections are [Enabled] and [Disabled]. The factory setting is [Disabled].

■ AGP Master 1 WS Write

Designates the wait time used when writing data to the AGP.

Available selections are [Enabled] and [Disabled]. Selecting [Enabled] means there is no wait time. The factory setting is [Disabled].

■ AGP Master 1 WS Read

Designates the wait time used when reading data from the AGP.

Available selections are [Enabled] and [Disabled]. Selecting [Enabled] means there is no wait time. The factory setting is [Disabled].

3.2.5 Integrated Peripherals

Selecting INTEGRATED PERIPHERALS SETUP menu item Displays the following screen.

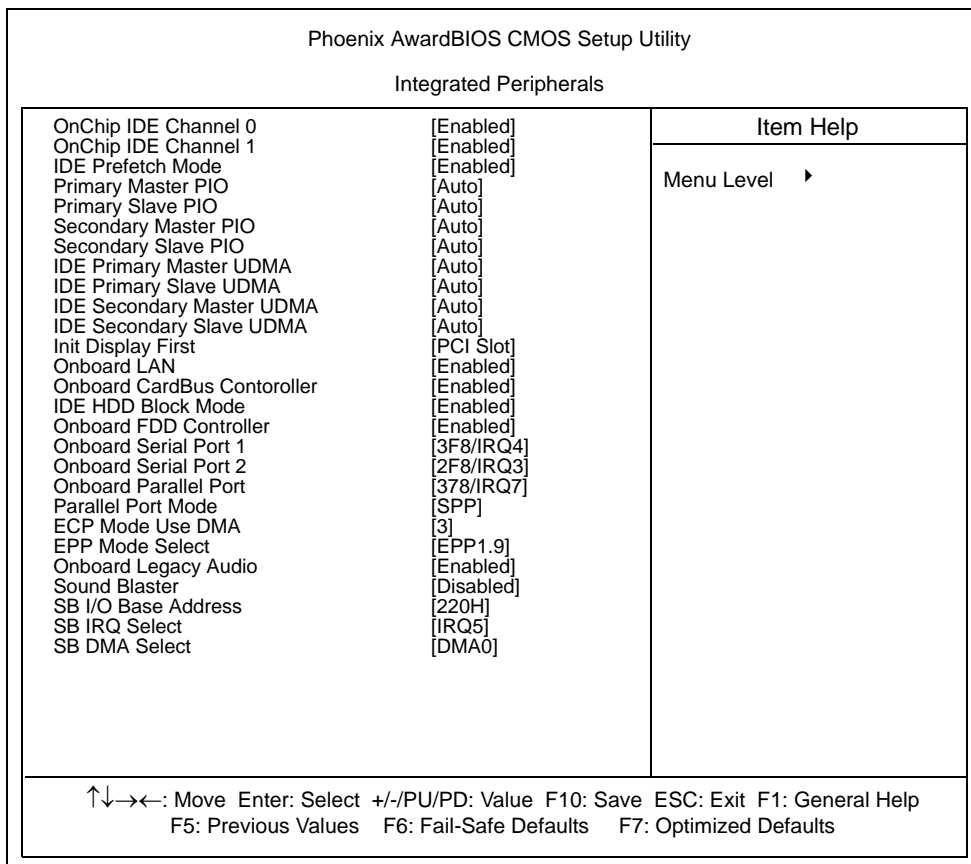

■ OnChip IDE Channel 0

Designates if the Primary IDE Controller is enabled.

Available selections are [Disabled] and [Enabled]. The factory setting is [Enabled].

■ OnChip IDE Channel 1

Designates if the Secondary IDE Controller is enabled.

Available selections are [Disabled] and [Enabled]. The factory setting is [Enabled].

■ IDE Prefetch Mode

Designates the IDE's read-priority mode.

Available selections are [Disabled] and [Enabled]. The factory setting is [Enabled].

■ Primary (Secondary) Master (Slave) PIO

Designates the IDE Primary (Secondary) Master (Slave) channel's PIO data transfer mode.

Available selections are [Auto], [Mode 0], [Mode 1], [Mode 2], [Mode 3] and [Mode 4].

The factory setting is [Auto].

■ IDE Primary (Secondary) Master (Slave) UDMA

Designates the IDE Primary (Secondary) Master (Slave) channel's UDMA data transfer mode.

Available selections are [Disabled] and [Auto]. The factory setting is [Auto].

■ Onboard LAN

Disables/enables the LAN connector. The available settings are [Disabled] and [Enabled]. The factory default setting is [Enabled].

■ Onboard CardBus Contoroller

This setting determines whether to enable the CardBus Contoroller or not. Settings available are [Disabled] or [Enabled]. The [Enabled] selection is factory set.

■ Init Display First

When both a PCI and an AGP display boards are installed, this setting designates which will have first priority. Settings are [PCI slot] or [Onboard/AGP]. The factory default setting is [PCI slot].

■ IDE HDD Block Mode

This setting determines whether to enable the Block Mode on the HDD supporting the Block Mode.

The available settings are [Disabled] and [Enabled]. The factory default setting is [Enabled] and is recommended for most users.

■ Onboard FDD Controller

Designates whether the PS-A's FDD(Floppy Disk Drive) controller is enabled or disabled.

Settings available are [Disabled] or [Enabled]. The [Enabled] selection is factory set.

■ Onboard Serial Port 1

Designates the PS-A's Serial Port 1 I/O address and Interruption. The selections include [Disabled], [Auto], [3F8/IRQ4], [2F8/IRQ3], [3E8/IRQ4] and [2E8/IRQ3]. The [3F8/IRQ4] selection is factory set and recommended for most users.

■ Onboard Serial Port 2

Designates the PS-A's Serial Port2 I/O address Interruption. The selections include [Disabled], [Auto], [3F8/IRQ4], [2F8/IRQ3], [3E8/IRQ4] and [2E8/IRQ3]. The [2F8/IRQ3] selection is factory set and recommended for most users.

■ Onboard Parallel Port

Selects the PS-A Parallel Port 1's I/O Address. The selections include [Disabled], [3BC/IRQ7], [378/IRQ7] or [278/IRQ5]. The [378/IRQ7] selection is factory set and recommended for most users.

■ Parallel Port Mode

Here, the parallel port's operation mode can be selected ([SPP], [EPP], [ECP], or [ECP + EPP]). Normally, [SPP] is used and recommended for most users. When [Disabled] is not selected, the [SPP], [ECP], [ECP + EPP1.9], [ECP + EPP1.7], [EPP], [EPP1.7 + SPP], [EPP1.9 + SPP] or [Normal] setting can be used.

■ ECP Mode Use DMA

Designates the ECP mode's DMA channel. [1] and [3] are available selections, however, this item can be set only when the Parallel Port Mode is not set to [ECP] or [ECP + EPP1.7] or [ECP + EPP1.9]. The factory default setting is [3].

■ EPP Mode Select

When [EPP] or [ECP + EPP] mode is selected, this feature allows you to select the EPP mode protocol.

When [ECP] or [ECP + EPP] is selected for Pararallel Port Mode, [EPP 1.7] or [EPP 1.9] can be selected. The factory default setting is [EPP 1.9].

■ Onboard Legacy Audio

Designates if audio features are Sound Blaster Pro compatible.

Available selections are [Disabled] and [Enabled]. The factory setting is [Enabled].

■ Sound Blaster

Available selections are [Disabled] and [Enabled].

When [Enabled] is selected, the unit is Sound Blaster Pro compatible.

The factory setting is [Disabled].

■ SB I/O Base Address

Designates the Sound Blaster Pro's I/O address.

Available selections are [220H], [240H], [260H] and [280H]. The factory setting is [220H].

■SB IRQ Select

Designates the Sound Blaster Pro's IRQ.

Available selections are [IRQ5], [IRQ7], [IRQ9] and [IRQ10]. The factory setting is [IRQ5].

■SB DMA Select

Designates the Sound Blaster Pro's DMA.

Available selections are [DMA0], [DMA1], [DMA2] and [DMA3]. The factory setting is [DMA0].

3.2.6 Power Management Setup

Selecting the POWER MANAGEMENT SETUP menu item calls up the following screen.

Phoenix AwardBIOS CMOS Setup Utility		
Power Management Setup		
ACPI Function	[Enabled]	Item Help Menu Level ▶
Power Management	[User Define]	
PM Control by APM	[Yes]	
Video Off Option	[Suspend->Off]	
Video Off Method	[DPMS]	
Wake Up Events	[Press Enter]	
↑↓→←: Move Enter: Select +/-/PU/PD: Value F10: Save ESC: Exit F1: General Help F5: Previous Values F6: Fail-Safe Defaults F7: Optimized Defaults		

■ACPI Function

Enables/disables the ACPI feature. Selections are [Enabled] or [Disabled].

[Enabled] is factory set and recommended for most users.

■Power Management

You can choose from three power management options. These are [User Define], [Min Saving] or [Max Saving]. The [User Define] selection is factory set and recommended for most users.

■PM Control by APM

Designates if the "Save Power" function is controlled by the APM.

Available selections are [Yes] and [No]. The factory setting is [Yes].

■Video Off Option

Controls monitor OFF settings. Available selections are [Suspend->Off], [Always On] and [All Modes->Off].

The factory setting is [Suspend->Off].

■Video Off Method

This setting determines the method to blank the display screen. The available settings are [Blank Screen], [V/H SYNC+Blank], and [DPMS]. The [Blank Screen] selection blanks the display. The [V/H SYNC+Blank] blanks the display and also suspends the Vertical/Horizontal synchronization signal of the display. The [DPMS] selection controls the operation when a CRT that supports DPMS^{*1} is used. The factory default setting is [DPMS] and is recommended for most users.

■Wake Up Events

Pressing the [Enter] key displays the types of events that can be set to trigger the switch between suspend and normal modes. Designates the mode switched to for each event.

*1 This standard is approved by the VESA (Video Electronics Standards Association).

3.2.7 PnP/PCI Configurations

Selecting the PnP/PCI Configuration menu item Displays the following screen.

Phoenix AwardBIOS CMOS Setup Utility		
PnP/PCI Configurations		
PNP OS Installed	[No]	Item Help
Reset Configuration Data	[Disabled]	Menu Level ▶ Default is Disabled. Select Enabled to reset Extended System configuration Data ESCD) when you exit Setup if you have installed a new add-on and the system reconfiguration has caused such a serious conflict that the OS cannot boot
Resources Controlled By	[Auto(ESCD)]	
× IRQ Resources	[Press Enter]	
× DMA Resources	[Press Enter]	
PCI/VGA Palette Snoop	[Disabled]	
↑↓→←: Move Enter: Select +/-/PU/PD: Value F10: Save ESC: Exit F1: General Help F5: Previous Values F6: Fail-Safe Defaults F7: Optimized Defaults		

■ PNP OS Installed

Available selections are [Yes] and [No]. Be aware that when [Yes] is selected, a plug-and-play compatible OS can cause interrupts to be re-allocated. The factory setting is [No] and is recommended for normal use.

■ Reset Configuration Data

Designates whether ESCD (Extended System Configuration Data) data should be erased or not. The two selections available are [Disabled] and [Enabled]. The [Disabled] selection is factory set and recommended for most users.

■ Resources Controlled By

The Plug-and-Play feature allows you to designate whether the allocation of I/O Port, IRQ and DMA resources is performed automatically or manually. The two selections available are [Manual] or [Auto(ESCD)]. If [Auto(ESCD)] is selected, the IRQ Resources and DMA Resources selection will be disabled. The [Auto(ESCD)] selection is factory set and recommended for most users.

■ IRQ Resources

When resources are controlled using [Manual], manually set each IRQ assignment.

SEE → 3.2.8 *IRQ Resources (page 3-19)*

■ PCI/VGA Palette Snoop

The two selections available are [Disabled] and [Enabled]. The [Disabled] selection is factory set and recommended for most users. However, if a VGA or MPEG board is used, set this to [Enabled]. For setting details, refer to your VGA or MPEG board's Installation guide.

3.2.8 IRQ Resources

Selecting IRQ Resources from the PnP/PCI Configuration menu and the following screen will appear.

Phoenix AwardBIOS CMOS Setup Utility		
IRQ Resources		
IRQ-3 assigned to	[PCI/ISA PnP]	Item Help
IRQ-4 assigned to	[PCI/ISA PnP]	Menu Level ▶ Legacy ISA for devices comPS-Biant with the original PC AT bus specification, PCI/ISA PnP for devices comPS-Biant with the PS-Bug and PS-Bay standard whether designed for PCI or ISA bus architecture
IRQ-5 assigned to	[PCI/ISA PnP]	
IRQ-7 assigned to	[PCI/ISA PnP]	
IRQ-9 assigned to	[PCI/ISA PnP]	
IRQ-10 assigned to	[PCI/ISA PnP]	
IRQ-11 assigned to	[PCI/ISA PnP]	
IRQ-12 assigned to	[PCI/ISA PnP]	
IRQ-14 assigned to	[PCI/ISA PnP]	
IRQ-15 assigned to	[PCI/ISA PnP]	
↑↓→←: Move Enter: Select +/-/PU/PD: Value F10: Save ESC: Exit F1: General Help F5: Previous Values F6: Fail-Safe Defaults F7: Optimized Defaults		

■ IRQ-3 (4/5/7/9/10/11/12/14/15) assigned to

This setting determines the type of device assigned to the IRQ. This function is available when the [PnP/ PCI Configurations] menu's [Resources Control By] option is set to [Manual].

[PCI Device].. Select to use a PnP-ready PCI card.

The available settings are [PCI Device] and [Legacy ISA].

The initial settings are all [PCI Device].

3.2.9 System Monitor Setup

Select PC Health Status from the System Monitor Setup and the following screen will appear.

Phoenix AwardBIOS CMOS Setup Utility		
System Monitor Setup		
Warning Voltage +3.3V	[Disabled]	Item Help Menu Level ▶
Warning Voltage +5V	[Disabled]	
Warning Voltage +12V	[Disabled]	
Warning Voltage -12V	[Disabled]	
CPU Fan Speed Limit	[Disabled]	
System Fan Speed Limit	[Disabled]	
Power Fan Speed Limit	[Disabled]	
↑↓→←: Move Enter: Select +/-/PU/PD: Value F10: Save ESC: Exit F1: General Help F5: Previous Values F6: Fail-Safe Defaults F7: Optimized Defaults		

■Warning Voltage +3.3V

When enabled, this setting designates that a warning will be issued if the voltage change exceeds +3.3V's designated range. The available settings are [Enabled] and [Disabled]. The factory default setting is [Disabled].

■Warning Voltage +5V

When enabled, this setting designates that a warning will be issued if the voltage change exceeds +5V's designated range. The available settings are [Enabled] and [Disabled]. The factory default setting is [Disabled].

■Warning Voltage +12V

When enabled, this setting designates that a warning will be issued if the voltage change exceeds +12V's designated range. The available settings are [Enabled] and [Disabled]. The factory default setting is [Disabled].

■Warning Voltage -12V

When enabled, this setting designates that a warning will be issued if the voltage change exceeds -12V's designated range. The available settings are [Enabled] and [Disabled]. The factory default setting is [Disabled].

■CPU Fan Speed Limit

When enabled, this setting designates the allowed speed range reductions allowed for CPU FAN. The available settings are [Enabled] and [Disabled]. The factory default setting is [Disabled].

■ Power Fan Speed Limit

When enabled, this setting designates the allowed speed range reductions allowed for Power FAN. The available settings are [Enabled] and [Disabled]. The factory default setting is [Disabled].

■ System Fan Speed Limit

If the system fan's RPM level falls below the set value, this feature, as part of system monitoring, issues a warning. The available settings are [Enabled] and [Disabled]. The factory default setting is [Disabled].

3.2.10 Frequency/Voltage Control

Selecting the Frequency/Voltage Control menu item produces the following screen.

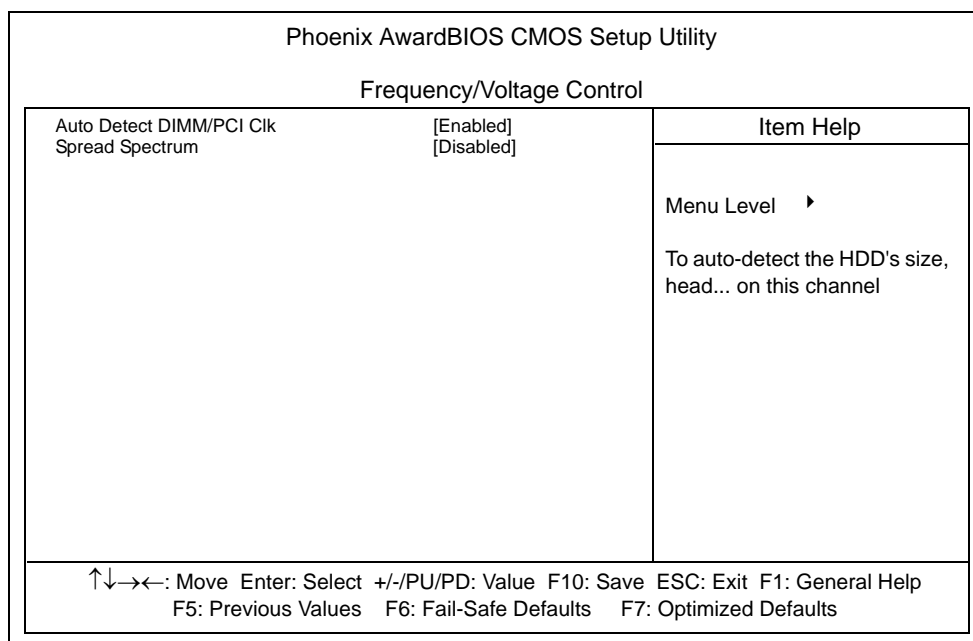

■ Auto Detect DIMM/PCI Clk

This setting designates the auto detect of the DIMM/PCI clock. The available settings are [Enabled] and [Disabled]. The factory default setting is [Enabled] and strongly recommended for users.

■ Spread Spectrum

This setting allows you to set the CPU Clock generator's spread Spectrum. The available settings are [Enabled] and [Disabled]. The factory default setting is [Disabled] and strongly recommended for users.

3.2.11 Load Fail-Safe Defaults

When the Menu screen's [Load Fail-Safe Defaults] is selected, you are able to designate if the minimum number of System Settings is loaded in or not. The selections are [Y] and [N].

3.2.12 Load Optimized Defaults

Selecting [Load Optimized Defaults] designates whether or not you will revert to the PS-A unit's factory settings. The selections are [Y] and [N].

3.2.13 Set Supervisor Password

This password is used to change system information settings. It is designed to prevent unapproved users from changing the system information settings. Entering up to 8 characters here will overwrite the current password.

When you wish to have no password, click on the [Enter] key. Next, the words "PASSWORD DISABLE" will appear, providing confirmation that the Password is no longer set.

When password input is required, use the [Advanced BIOS Features] area's [Security Option] feature to enter the password.

SEE → 3.2.3 *Advanced BIOS Features (page 3-6)*

3.2.14 Set User Password

This password is used to view system information settings. It is designed to prevent unapproved users from viewing the system information settings. Entering up to 8 characters here will overwrite the current password.

When you wish to have no password, click on the [Enter] key. Next, the words "PASSWORD DISABLE" will appear, providing confirmation that the Password is no longer set.

When password input is required, use the [Advanced BIOS Features] area's [Security Option] feature to enter the password.

SEE → 3.2.3 *Advanced BIOS Features (page 3-6)*

IMPORTANT

- When using either [Set Supervisor Password] or [Set User Password], you can easily view and change system settings.
- When using BOTH the [Set Supervisor Password] and [Set User Password] features, [Set User Password] will allow you to only view system data, not change it.

3.2.15 Save & Exit Setup

This feature saves the settings entered in the Setup Utility and restarts the PS-A unit.

3.2.16 Exit Without Saving

This feature quits the Setup Utility program without saving any settings entered.

4

Setting up Your PS-A Unit

1. CD-ROM Contents
2. Setting Up Your PS-A Unit
3. Installing Drivers
4. Special Application Program Features
5. When Using Windows® 2000/Windows® XP

4.1 CD-ROM Contents

4.1.1 Software

This section explains the organization of the software included in the accessory CD-ROM.

PS370XA-E66 User Manual & Driver CD

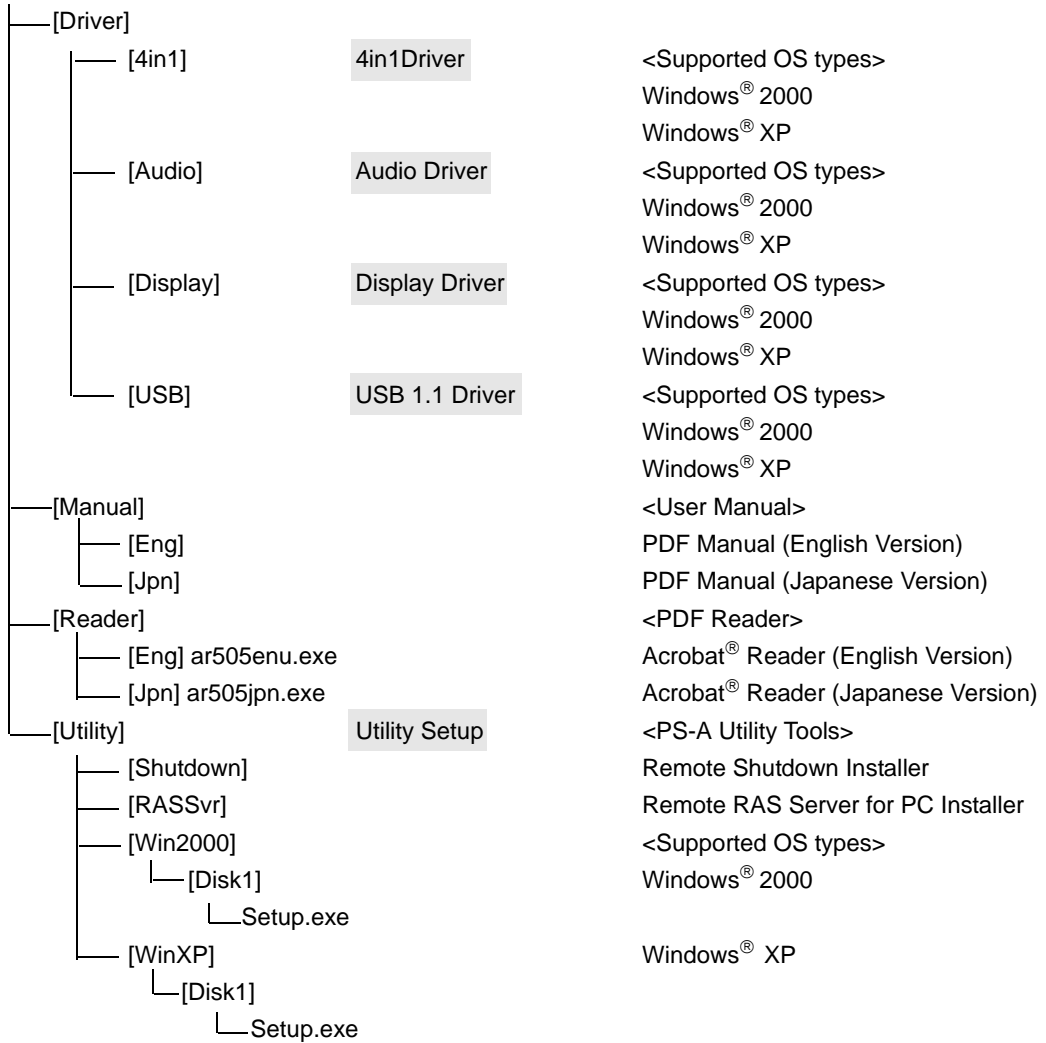

4.2 Setting Up Your PS-A Unit

There are two types of PS-A units. One has a hard disk with no pre-installed OS and one has a hard disk with a pre-installed OS. Therefore, the setup procedures used will differ. This manual describes only the procedures for setting up a PS-A unit using a hard disk with no pre-installed OS. For an explanation of how to set up a PS-A using a hard disk with a pre-installed OS, refer to the “Pre-installed Type Installation Guide”, provided with the HDD unit.

4.2.1 Setup Procedures

First, you will need to install either Windows[®] 2000 or Windows[®] XP. You also need to install any required utility software.

■ Installing the HDD Unit

Check to see if a hard disk unit is installed in your PS-A unit. If it is not, please install one prior to going to the next step.

SEE → *PSA-HD20 Installation guide*

■ Setting Up HDD Unit System Information

After you install your HDD unit, you will need set up a variety of system information. Set up this information so that the system recognizes the newly-installed hard disk drive.

SEE → *PSA-HD20 Installation guide*

■ Setting Up the OS

Install your operating system. For detailed setup procedures, refer to that product's installation manual.

IMPORTANT

- The PS-A unit supports the following two OS. PS-A unit performance cannot be guaranteed when any other operating system is used.

Windows[®] 2000 Service Pack 4

Windows[®] XP Service Pack 1/Service Pack 2

■ PS-A Utility Setup

Install the necessary drivers and utility software from the “PS370XA-E66 User Manual & Driver CD”.

NOTE

- A PS/2 (mini-DIN) type keyboard or a USB keyboard is required to install the OS.
- When using a touch panel display with the PS-A, the touch panel will require an optional mouse emulator (PL-TD000).

◆ Installing Software from the PS370XA-E66 User Manual & Driver CD-ROM

To begin the installation, click on the “Setup.exe” file in your OS’ folder.

Example) With Windows® XP

D:\Utility\WinXP\Disk1\Setup.exe (When the CD-ROM drive is “D”)

└─ For Windows® 2000, this will be “Win2000”.

◆ PS-A Hard Disk Data

Setting up the PS-A unit’s utilities will create a [Proface] folder on the C drive. The following diagram describes the configuration of this folder. (For all Windows® versions)

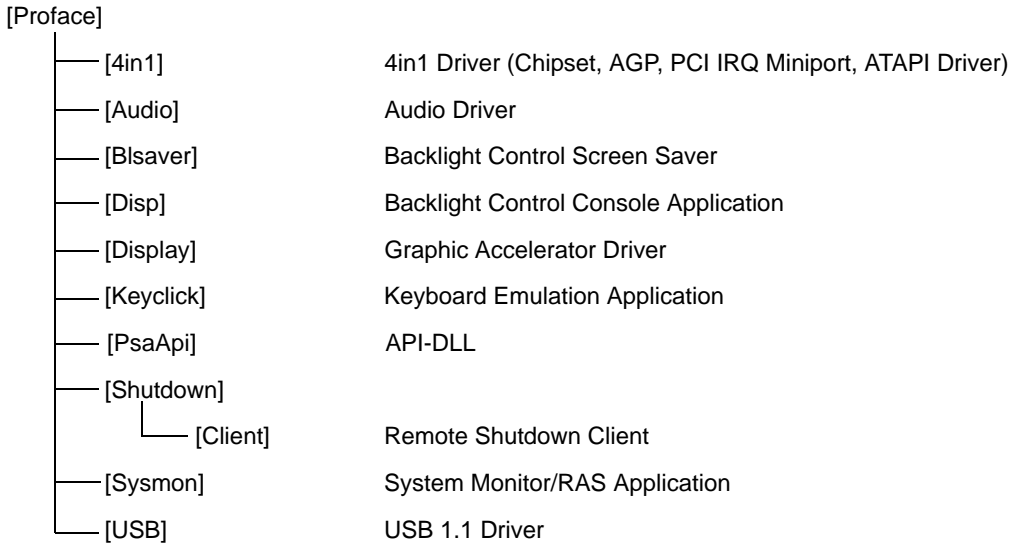

NOTE

- The actual organization may differ depending on your PS-A unit’s OS.
- Setting up the PS-A unit’s utilities automatically copies the hardware control driver (Psamon.sys, Blctrl.sys) to the system folder.

4.2.2 Setting Up an HDD with Pre-installed OS

Use the following steps to set up your PS-A unit’s HDD unit, which contains the Windows® 2000 operating system, related drivers and utility software.

NOTE

- Each pre-installed operating system is designed specially for the PS3701A (Eden™ ESP6000 - 667MHz Model) unit.
- “Service Pack 4” is included in the Windows® 2000 HDD unit.

■ Installing the HDD Unit

After opening the PS-A unit's packing box, check that a hard disk unit is installed. If it is not, you will need to install it.

SEE → *Pre-installed HDD Unit Installation Guide*

■ Setting Up the PS-A Unit's System Information

If your PS-A unit does not have a pre-installed HDD, you will need to install an HDD unit and then configure that drive's system information. Be sure to check that the system successfully recognizes the drive.

SEE → *Pre-installed HDD Unit Installation Guide*

■ Setting Up an HDD with Pre-installed OS

Follow the setup procedures given in the Pre-installed Type HDD Unit Installation Guide.

◆ PS-A Hard Disk Data

Setting up the PS-A unit's utilities will create a [Proface] folder on the C drive. The following diagram describes the configuration of this folder. (For all Windows® versions)

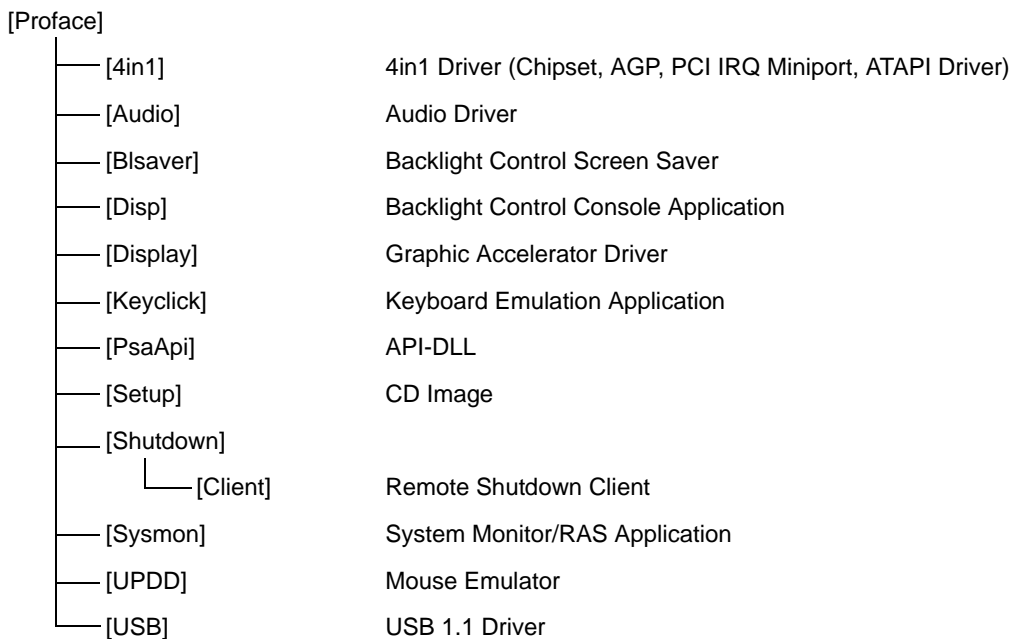

NOTE

- The actual organization may differ depending on your PS-A unit's OS.
- Setting up the PS-A unit's utilities automatically copies the hardware control driver (Psamon.sys, Blctrl.sys) to the system folder.

4.3 Installing Drivers

Four types of dedicated PS-A drivers (4in1, Audio, graphic accelerator, and USB 1.1) are available.

Install the required drivers from this data when using a PS-A with no pre-installed OS (A PS-A unit that has been recovered using the Recovery CD-ROM will have all the required drivers installed).

This explanation given in this section assume that the [Proface] folder has been created.

IMPORTANT

- Once drivers are installed in the PS-A unit, they cannot be uninstalled.

■ Installing the 4in1 Driver

Installing the 4in1 driver makes the followings installed; Chipset, AGP, PCI IRQ Miniport and ATAPI Driver.

- (1) Double-click on the “VIAHyperion4in1449v.exe” file located in the following folder. Follow the instructions given to install the driver.

C:\Proface\4in1\VIAHyperion4in1449v.exe

■ Installing the Audio Driver

Installing the Audio driver enables the OS' Audio feature.

- (1) Double-click on the “Setup.exe” file located in the following folder. Follow the instructions given to install the driver.

C:\Proface\Audio\Setup.exe

■ Installing the Graphic Accelerator Driver

Installing the Graphic Accelerator Driver will accelerate the screen refresh speed, using special hardware features.

- (1) Start “C:\Proface\Display\Setup.exe” file.
- (2) Select [Next]-[Yes]-[Exit], and then restart the system to complete the installation.

■ USB 1.1 Driver Installation

This section describes how to install a USB 1.1 driver into your PS-A unit. Doing so ensures that both bottom-face USB connectors (2 ports) and front-face USB connector (1 port) operate as a USB 1.1 port.

- (1) Double-click on the “Setup.exe” file located in the following folder. Follow the instructions given to install the driver.

C:\Proface\USB\Setup.exe

4.4 Special Application Program Features

The special programs designed for the PS-A unit are located in the following folders.

File Name	Windows® XP	Windows® 2000
PSA_RAS.DLL	C:\Windows\System32	C:\Winnt\System32
PSA_DLL.DLL		
PSA_IOC.DLL		
PSA_BLC.DLL		
Backlight Control.scr		
BI Bright.cpl		
Disp.exe	C:\Proface\Disp	
Keyclick.exe	C:\Proface\Keyclick	
PSA_Smon.exe	C:\Proface\Sysmon	
PSA_Wps.exe	C:\Proface\Sysmon	
Psamon.sys	C:\Windows\	C:\Winnt\System32\
Bctrl.sys	System32\Drivers	Drivers

■ API-DLL

These dynamic link libraries allow users to access RAS features via custom-made applications. The following four types are available.

◆ Shared Memory Access: PSA_RAS.DLL

This dynamic link library allows users to access shared memory via remote RAS features.

SEE → *For details, refer to the API Reference Manual.*

◆ System Monitoring: PSA_DLL.DLL

This dynamic link library allows users to access the PS-A unit's system monitor feature.

◆ RAS Features: PSA_IOC.DLL

This dynamic link library allows users to access RAS features via custom-made PS-A applications.

SEE → *For details, refer to the API Reference Manual.*

◆ Backlight Control API-DLL file (PSA_BLC.DLL)

This API-DLL file provides a dynamic library that allows User-created applications to utilize the PS-A backlight control feature. This file must be installed into the same directory as the User's application.

SEE → *For details, refer to the API Reference Manual.*

■ System Monitoring/RAS Applications: PSA_Smon.exe/PSA_Wps.exe

The RAS and System Monitoring features allow users to monitor temperature voltage, and fan operation alarms. This program runs on Windows®.

◆ System Monitoring Program: PSA_Smon.exe

SEE → *5.2.3 System Monitoring Operation (PSA_Smon.exe) (page 5-9)*

◆ Watchdog Parameter Setup Program: PSA_Wps.exe

SEE → 5.2.2 System Monitoring Property Settings (PSA_Wps.exe) (page 5-7)

■ System File: Psamon.sys

This system file allows use of the RAS and System Monitoring features. This file should not be modified. If it is modified, the RAS and System Monitoring features may not operate correctly.

■ Backlight OFF Screen Saver (Backlight Control.scr)

This software is used to turn OFF the PS-A's backlight after a specified period of inactivity. The use of this feature will help to extend the life of the PS-A's backlight.

NOTE • Certain application programs may not allow the PS-A's backlight to turn OFF. Please test each program individually to check if the screen saver will operate correctly.

■ Screen Display ON/OFF Utility (DISP.EXE)

This command line utility is used to turn OFF both the PS-A's backlight and display.

Settings Used	DISP [ON/OFF]
Option Switch	ON: Displayed / OFF: Not Displayed
Return Value	0: Completed Normally / -1: Option Switch Error

IMPORTANT • If your application requires that the OS continuously turn the Windows® backlight display ON and OFF, be sure to use the backlight control dll, PSA_BLC.DLL.

■ Keyboard Emulator (Keyclick.exe)

This program allows the User's mouse operation to perform keyboard-like data input.

NOTE • Certain application programs do not support this keyboard emulator. Please test each application individually to check if the keyboard emulator will operate correctly.

- This application cannot be used to enter Windows® startup screen User Name and Password information.
- To change the Keyclick program's font size a keyboard is required.
- For details concerning the Keyclick program's operation, simply click on the HELP button to call up the program's online help data.

■ Backlight Brightness Adjustment (BI Bright.cpl)

Backlight brightness can be set to one of four levels: Level 0, Level 1, Level 2 or Level 3.

Brightness level 0: Very dark

Brightness level 1: Somewhat dark

Brightness level 2: Somewhat bright

Brightness level 3: Very bright

To use this program, click the [Control Panel]'s [Backlight Brightness] icon.

4.4.1 Uninstalling Utility Software

Utility programs can be uninstalled using the following procedure.

- (1) Click on the [Control Panel] icon.
- (2) Click on the [Add/Remove Programs] icon and from the list of installed programs that appears, select [PS370XA-E66 Driver and Utility] and click [Add/Remove].

IMPORTANT

- Once drivers are installed in the PS-A unit, they cannot be uninstalled.

4.5 When Using Windows® 2000/Windows® XP

4.5.1 Automatic System Log-on Setup

This setting allows users to simplify password entry at startup.

■ Windows® 2000

- (1) Double-click on the [Control Panel]'s [User and Password] icon.
- (2) Designate the automatic logon user, and deselect the [User must enter the user name and password to use this computer] checkbox.
- (3) Click on the [Advanced] tab, and deselect the [Require users to press Ctrl +Alt + Del keys before logging on] checkbox.
- (4) Click the [Apply] button. Next, when the automatic logon dialog box appears, enter the password.

■ Windows® XP

- (1) Select [Run] from the [Start] menu.
- (2) Enter "Control userpasswords", and click [OK].
- (3) Deselect the [User must enter the user name and password to use this computer] checkbox and click [Apply].
- (4) Enter the user name and password for automatic logon and click [OK].

IMPORTANT • A password must be assigned for user to perform automatic logon.

NOTE • If automatic logon is not used, a PS/2 (mini-DIN) type keyboard is required to logon.

4.5.2 Uninterrupted Power Supply System (UPS)

Be sure to shut down your OS before turning off your machine. Also, use of an uninterrupted power supply is recommended to protect your data from accidental power failures.

An uninterrupted power supply will give you sufficient time to shut down your system safely in case of a power failure, and can even be set up to automatically shut down your Windows® OS.

The PS-A unit, however, cannot be used with a 2-Step Inverter Output type uninterrupted power supply. Be sure the unit is a sine-output type power supply. For details, consult your local UPS system dealer.

4.5.3 Changing System Settings

Your Windows® system's configuration settings will need to be changed when the PS-A unit is connected to a LAN network or printer.

◆ Changing the System Configuration Settings

When the Windows® system configuration settings are changed, the following message appears. Enter the name of the folder where you will save the configuration changes and click [OK].

- Insert the CD labeled “Windows® xx*1 Professional CD-ROM” in the CD-ROM drive (D:), and click [OK].
- When copying the file from other locations such as a floppy disk or network server, also click the [OK] button.

- When Your PS-A has No Preinstalled OS
Double-click the [I386] folder in the Windows® CD-ROM.
D:\I386 (When the CD-ROM drive is "D")
- When Your PS-A has a Preinstalled OS
C:\Proface\Setup\I386

4.5.4 NTFS File System Conversion

If your PS-A unit has a pre-installed OS, or if your OS is formatted with the Windows® DOS-compatible file system (FAT32), it can be converted to the NTFS file system.

To convert to the NTFS file system, start up Windows® and use the following command.

convert X: /fs:ntfs (Replace “X” with your drive name.)

NOTE

- Once the file system is converted to the NTFS file system, it cannot be converted back to the Windows® DOS-compatible file system (FAT32).

*1 “xx” is your OS.

Example) When using Windows® XP: “Windows® XP Professional CD-ROM”

Memo

5



Monitoring Features

1. RAS Features
2. System Monitor/RAS Features
3. Error Displays When Using Event Viewer
4. Remote RAS
5. Remote Shutdown Feature

5.1 RAS Features

5.1.1 PS-A RAS Features

RAS (Reliability, Availability, Serviceability) features include a variety of useful system performance monitoring features, with the main feature being device monitoring. These features are designed to improve overall system reliability.

■Types of Monitoring

The PS-A unit supports the following Alarm Monitoring feature.

Error Monitoring	Power Voltage Alarm Cooling Fan RPM Alarm *1 Watchdog Timer Timeup Touch Panel Alarm Backlight Alarm SMART Alarm
------------------	---

*1 This unit's standard equipment does not include a cooling fan.

■Alarm Processing

The PS-A provides the following alarm processing (processing or external output signals) in response to the previous page's alarms, or to external signal input.

Types of Processing	LED Indicator (2 colors, 1 lamp) Pop-up Message Output Buzzer Output System Shutdown System Reset
---------------------	---

■ System Monitor

The System Monitor feature (software utilities) allows users to enable or disable the monitoring of any of the above monitoring items, as well as to individually set alarm processing settings.

SEE → 5.2 System Monitor/RAS Features (page 5-6)

In addition, System Monitor includes a dynamic link library (API-DLL) feature that gives other applications access to RAS features.

5.1.2 RAS Feature Details

■ Error Monitoring

◆ Power Voltage Alarm

Monitors the status of the PS-A unit's built-in power supply and internal CPU power supply.

◆ Cooling Fan Rotation Alarm^{*1}

Monitors the power-supply and CPU cooling fan RPM speeds.

◆ Watchdog Timer Timeup

This feature monitors the performance of the CPU by writing the CPU's time-up count value to the RAS feature's built-in programmable timer and by periodically clearing the count value from the CPU. Errors are detected when the clearing of the count value from the CPU stops, which will cause a timer overflow.

Use the System Monitor Property area to set the Watchdog Timer Timeup ON or OFF, and enter detailed error processing settings.

◆ Touch Panel Alarm

Detects Touch Panel alarms. When an alarm occurs, the LED will turn orange.

◆ Backlight Alarm

Detects Backlight alarms. When an alarm occurs the LED will flash orange/red.

◆ SMART Alarm

Monitors the status of the hard disk. Detects a warning of trouble of the hard disk.

IMPORTANT

- Administrator Authentication is required for executing SMART Monitoring.
- A CF card doesn't support SMART and therefore the status of the CF card cannot be monitored.
- When a hard disk except options made by Pro-face is used, operation of SMART Monitoring cannot be guaranteed.
- The SMART Monitor can be performed for the hard disk connected to the IDE only. The state of the hard disk connected via a USB or a SCSI cannot be monitored.

*1 This unit's standard equipment does not include a cooling fan.

■Types of Processing

The PS-A unit can send the following system status information to an external device.

◆ LED Indicator

The three-color LED is used to indicate PS-A system conditions. It is also used as a power ON/OFF indicator.

The LED is located on the front face of the PS-A unit.

LED Color	System Status	Output Created
Green (Lit)	Normal Operation (Power ON)	None
Orange (Lit)	A RAS alarm has occurred.	LED is enabled via System Monitor Property.
	Touch Panel Self Test Error	None
Orange/Red (Lit)	Backlight is not functioning.	None

NOTE

- Immediately after the PS- A unit's power is turned ON, if the orange LED lights,a touch panel Self- Test Error may have occurred.

◆ Pop-up Message Output

This feature displays system status via a Windows® pop-up message.

System Monitor Property is used to enable or disable this feature.

◆ Buzzer Output

This feature uses the PS-A unit's built-in speaker to alert the operator about PS-A system status.

System Monitor Property is used to enable or disable this feature.

◆ System Shutdown

This feature shuts down the PS-A unit's OS.

System Monitor Property is used to enable or disable this feature.

◆ System Reset

This feature resets the system when the Watchdog Timer reaches "time up".

System Monitor Property is used to enable or disable this feature.

5.1.3 RAS Feature Overview

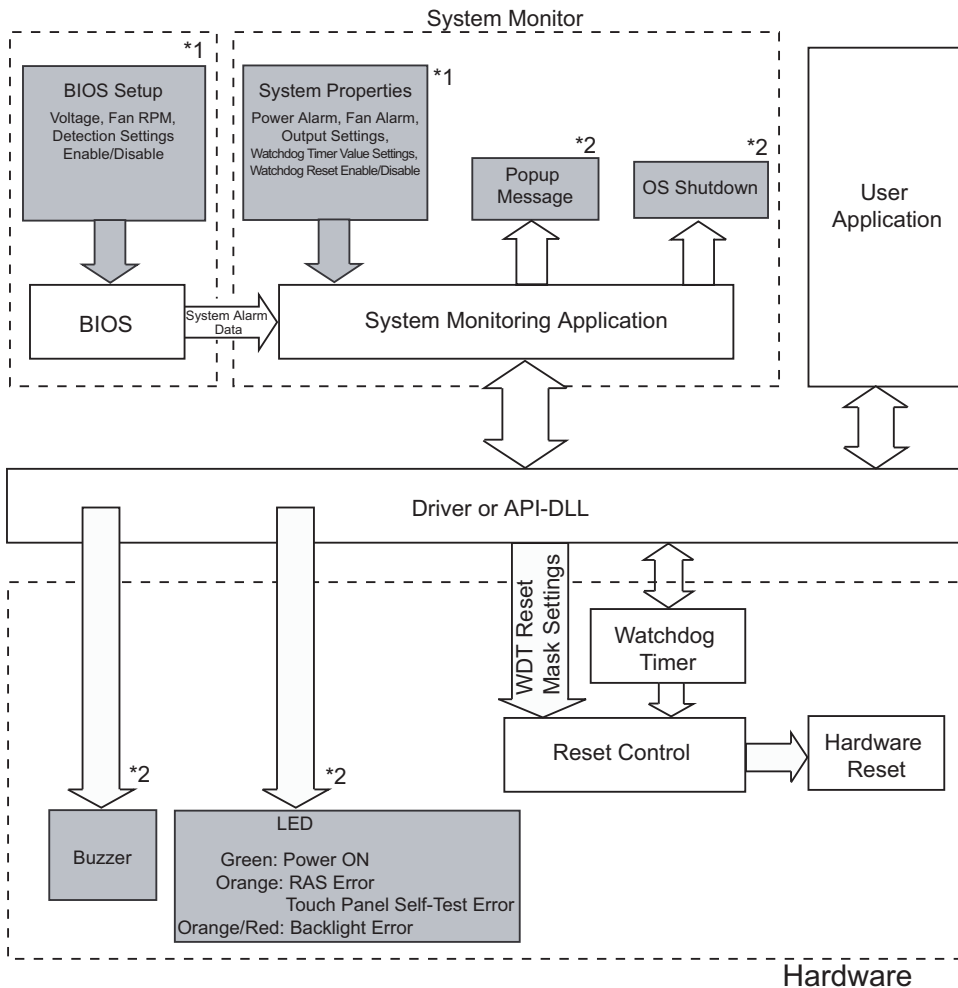

*1 Be sure to adjust these settings according to your system's specifications.

SEE → 5.2 System Monitor/RAS Features (page 5-6)

*2 Output via the RAS feature.

5.2 System Monitor/RAS Features

5.2.1 Setup Procedures

Follow the steps below to enable the System Monitor/RAS features.

■ Via System Monitor Setup Screen

Use the [System Monitor Setup] menu's System Setup screen to enable or disable monitoring features.

SEE → 3.2.9 System Monitor Setup (page 3-20)

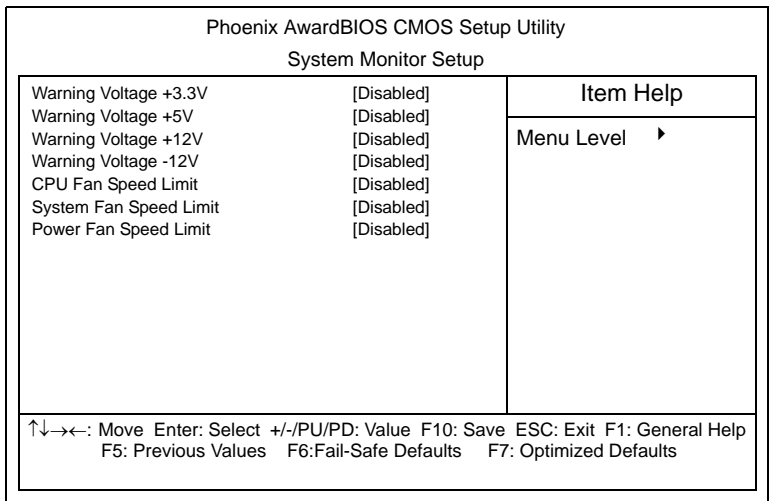

■ Via Applications

Start the PS-A unit's OS and start up the System Monitor Property using the [Start] → [Programs] → [System Monitor] → [System Monitor Property] commands. Next, set the processing to be performed when a System Monitor/RAS event occurs.

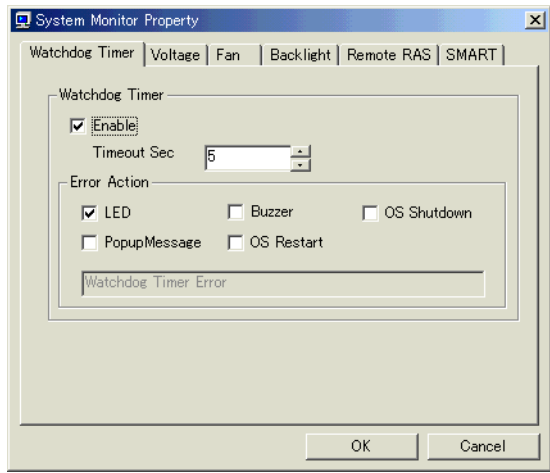

System status can be monitored at any time via the System Monitor. Select [Start] → [Programs] → [System Monitor]

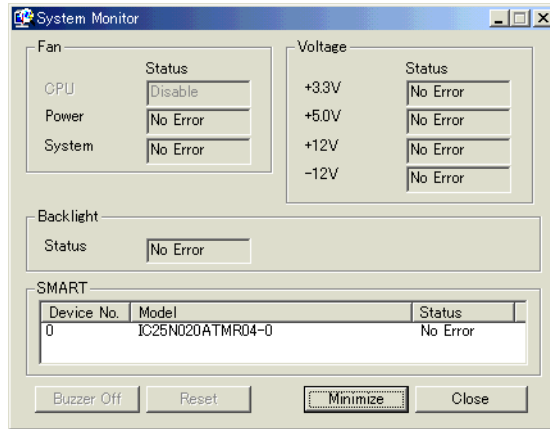

IMPORTANT

- Administrator Authentication is required for executing SMART Monitoring. When a user who does not have the administrator authentication logs in, nothing is displayed in the item of SMART.

5.2.2 System Monitoring Property Settings (PSA_Wps.exe)

The System Monitor Property screen allows you to configure the operating settings that are activated when system conditions exceed the allowable range (when an error occurs) of each monitoring device specified on the [System Monitor Setup] menu on the System Setup screen.

The following table lists the operating settings that can be configured for each feature.

O: Setting available X: Setting not available

Operation Feature	Buzzer	Popup Message	OS Shutdown	OS Reset	LED
Watchdog Timer	O	O	O	O	O
Voltage	O	O	O	X	O
Fan	O	O	O	X	O
Backlight	O	O	X	X	O
SMART	O	O	X	X	O

The following table lists the description of each operation.

Item	Operation
Buzzer	Sounds a beep as an alarm. (Cannot be set up when a checkmark is put to the "OS Shutdown" checkbox.)
Pop-up Message	Displays error messages as pop-up messages. (The messages pop up on the screen.)
OS Shutdown	Shuts down the operating system.
OS Reset	Restarts the operating system.
Enable	Select or deselect this option to enable or disable each setting of the monitoring feature.
LED	The front orange LED lights.

The following is the overview of the System Monitor Property setting screen.

Enable of disable the feature.

Set the timer

Specify the operation to be performed when the condition exceeds the allowable range.

Enter the message to be displayed as a pop-up message.

5.2.3 System Monitoring Operation (PSA_Smon.exe)

The System Monitor screen will not be displayed immediately after the System Monitor is started, instead, the icon will be stored in the System Tray.

When an error is detected, the “Operations (buzzer, pop-up message output, etc.)” set on the System Monitor Property are performed, and then an “X” mark appears on the icon on the System Tray, which indicates an error status. When the icon on the System Tray changes as illustrated below, double-click on the icon to review the description of the error condition.

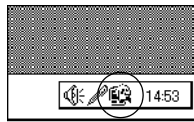

Icon display upon start-ups

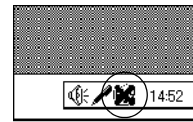

Icon display when an error is detected.

The following is the System Monitor screen.

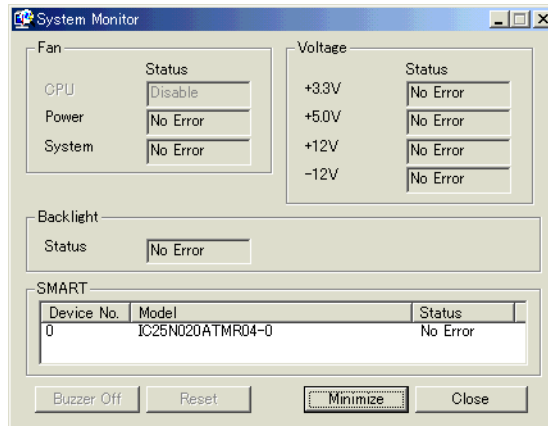

System Monitor Screen

NOTE

- As for Device No. of SMART, [0] means Master and [1] means Slave.

The [Buzzer Off], [Reset], [Minimize], [Close] buttons are located at the bottom of the System Monitor screen. The following table lists the features of the buttons.

Button	Operation
Buzzer Off	Stops the buzzer sounds at normal operations.
Reset	Clears the error condition held at normal operations and inside the System Monitor.
Minimize	Minimize the System Monitor into the icon display.
Close	Closes the System Monitor.

The System Monitor screen displays whether the each parameter of “FAN/VOLTAGE/SMART” is disabled or in normal/abnormal condition. The following table lists the status to be displayed.

Display	Meaning
No Error	Normal
Error	Abnormal
Disable	Monitoring disabled
Not Support	Not support

NOTE

- [Not Support] is displayed when a device like a CF card, which does not support SMART, is detected.

The system performs the Error Action set in the System Monitor Property when an error condition is detected with each monitoring item.

SEE →

5.2.2 System Monitoring Property Settings (PSA_Wps.exe) (page 5-7)

The Error Action is performed only one time when an error is detected for each monitoring item.

For example, look at the “+3.3 V” and “+5.0 V” options in the Voltage field. When the pop-up message feature for monitoring the voltage status is enabled, the pop-up message “+3.3 V Power Supply Error” appears on the screen when the +3.3 V power supply error occurs. Press the [OK] button on the dialog box to hide the message. The “+3.3 V Power Supply Error” will not appear even when a +3.3 V power supply error occurs again. However, when a +5.0 V power supply error occurs, the pop-up message “+5.0 Power Supply Error” appears on the screen. The pop-up message displays the monitored item and error description. When the buzzer feature is enabled, press the [Buzzer Off] button on the pop-up message to stop the buzzer sound. Press the [OK] button to close the pop-up message.

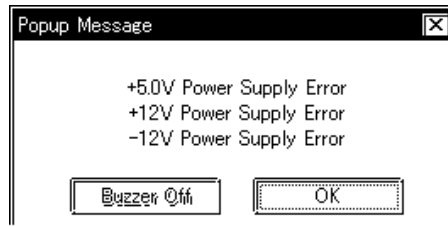

Output Screen of Pop-up Message

When “OS Shutdown” is enabled, the system automatically enters the shutdown operation without prompting the confirmation message for the user. To display the System Monitor screen for reviewing the current condition, double-click on the icon on the System Tray.

When the buzzer sounds as an Error Action, the System Monitor screen displays the [Buzzer Off] button that is hidden under normal conditions. When a pop-up message window is displayed, the [Buzzer Off] button appears on the window.

IMPORTANT

- Once an error is detected, the System Monitor holds the “error” status. (Displays the icon indicating the error status.) To recover from the error status, press the [Reset] button on the System Monitor screen, or turn off the PS-A, perform maintenance service for removing the cause of the error, and then turn on the power again.

5.2.4 Error Messages

This section describes the error message and closing messages displayed on the System Monitor and System Monitor Property screens.

■ System Monitor

◆ Error Pop-up Message

When an error occurs while the “Pop-up Message” option is enabled for Error Action, the following messages appears on the pop-up screen output screen under the factory-configured settings.

Error-generating Item	Message
+3.3V Voltage	"+3.3V Power Supply Error"
+5.0V Voltage	"+5V Power Supply Error"
+12V Voltage	"+12V Power Supply Error"
-12V Voltage	"-12V Power Supply Error"
Power FAN	"Power FAN Error"
CPU FAN	"CPU FAN Error"
System FAN	"System FAN Error"
Watch dog	"Watch Dog Timer Error"
Backlight	"Backlight Error"
SMART	"SMART Error"

NOTE

- The messages displayed on the pop-up message output screen can be modified on the System Monitor Property screen.

◆ Driver Non-Operation Error

“The System Monitor driver not found.”

“Install the latest driver.”

◆ Driver Version Error

“The old System Monitor driver version.”

“Update the driver.”

◆ Overlapped Startup Message

“System Monitor has started.”

“Terminate the System Monitor in starting.”

◆ Closing Confirmation Message

“The System Monitor is terminated.”

“Are you sure?”

■ System Monitor Property

◆ Overlapped Startup Message

“System Monitor property has started.”

“Terminate the System Monitor Property.”

◆ Closing Confirmation Message

“Save Changes to the registry?”

5.3 Error Displays When Using Event Viewer

Error type/location and error actions are recorded as error events in the System Log. Error event information can be checked using the Event Viewer.

NOTE • This feature can be used with Windows® 2000, Windows® XP.

5.3.1 Error Message Display

- (1) Start the [Control Panel]->[Administrative Tools]->[Event Viewer], and select [System Log].

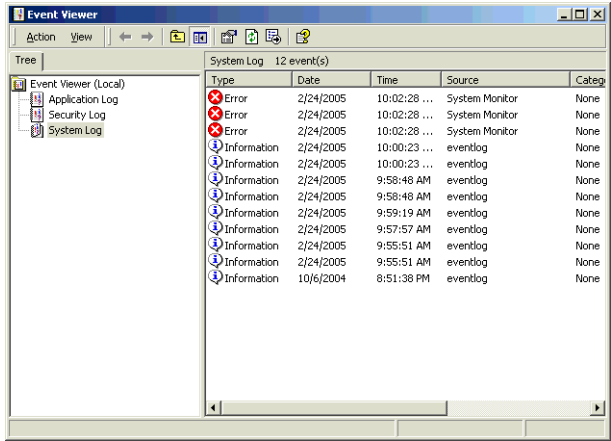

- (2) Select the System Monitor's error and click the [Properties] icon. When the [Event Properties] dialog box appears, the error message will appear in the [Description] area.

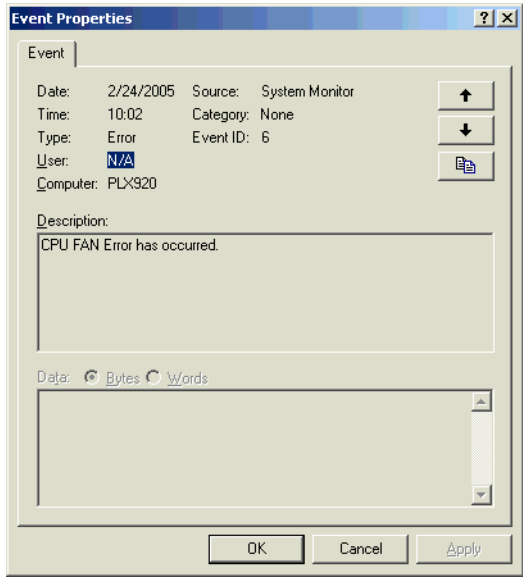

5.3.2 Error Type/Location

The error types/locations shown by the Event Viewer are as follows.

Error Type/Location	Error Message
+3.3V	+3.3V Error has occurred.
+5.0V	+5.0V Error has occurred.
+12V	+12V Error has occurred.
-12V	-12V Error has occurred.
CPU FAN	CPU FAN Error has occurred.
Power FAN	Power FAN Error has occurred.
System FAN	System FAN Error has occurred.
Watch Dog Timer	Watch Dog Timer Error has occurred.
Backlight	Backlight Error has occurred.
SMART	SMART Error has occurred. Attribute (No.) (Attribute Name) Device (No.) (HD Model). The descriptions in the parentheses vary depending on details of occurring errors and the device having errors occur (0:Mas- ter, 1:Slave).

5.3.3 Error Action

Using the Event Viewer the following actions can be taken when an error occurs.

NOTE

- The data shown in the table's "□" indicate the error type/location.
- The actions to take after an error occurs are set via the System Monitor Property screen.

Error Action	Error Message
Buzzer	Buzzer has sounded because of □□ error.
Popup Message	Popup Message has been shown because of □□ error.
OS Shutdown	Window has been shut down because of □□ error.
LED	LED has changed to orange because of □□ error.

When a "+3.3V" error occurs and the buzzer sounds, two errors will be displayed, "+3.3V Error has occurred." and "Buzzer has sounded because of +3.3V error".

5.4 Remote RAS

The Remote RAS feature uses the Pro-face's Pro-Server with Pro-Studio (optional) installed in the host PC to monitor and control the System Monitor/RAS feature of the PS-A.

Pro-Server with Pro-Studio Ver.3.12 of higher is required to use the Remote RAS feature. When using this feature, refer to the installation guides provided with the Pro-Server as well as this manual.

5.4.1 System Configuration

The system employing this feature is configured as illustrated below.

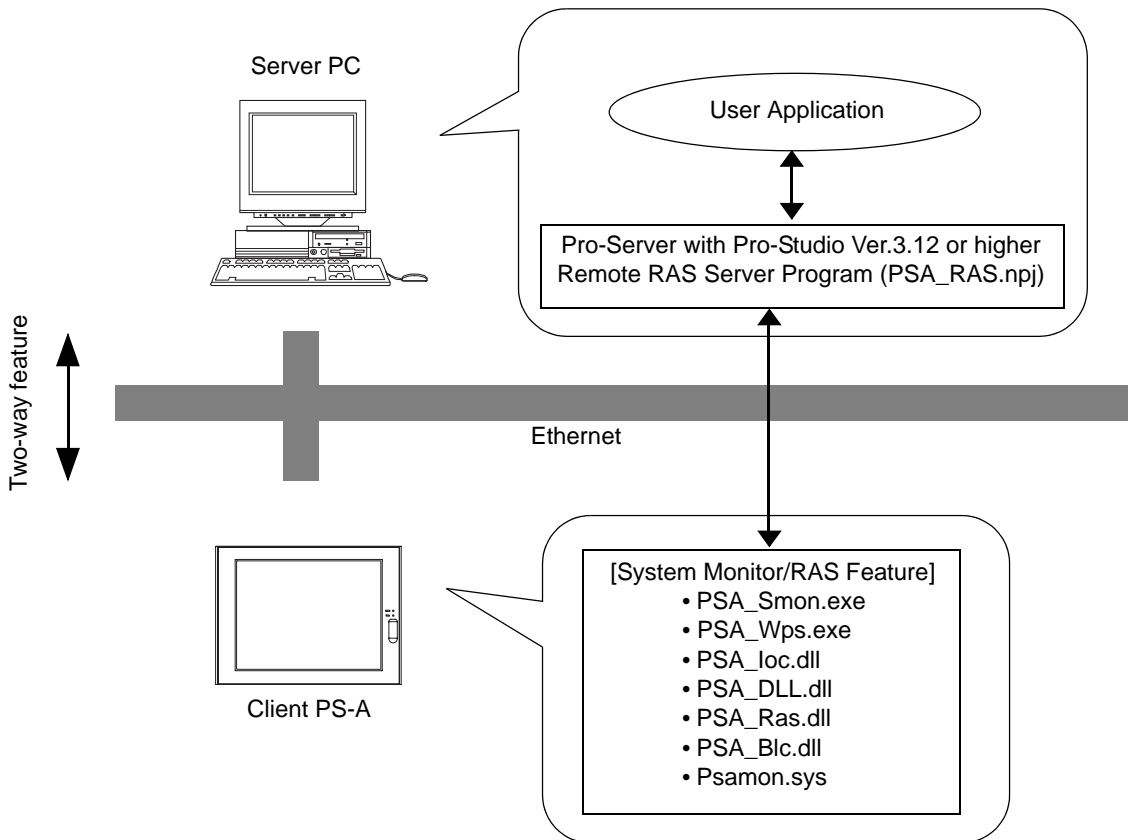

5.4.2 Installation Procedures

On the server PC, start up the “Setup.exe” file in the [RASSvr] folder on the accessory CD-ROM, and then install the program by following the instructions on the screen.

5.4.3 Setup and Preparation of the Remote RAS Feature

In order to monitor the System Monitor/RAS features from the server PC, you are required to set up the Remote RAS feature and start up the System Monitor (PSA_Smon.exe).

■ Setting Up the Client PS-A

- (1) Select [Start] → [Programs] → [System Monitor] → [System Monitor Property] commands to start the System Monitor Property.
- (2) On the [Remote RAS] tab, put a check mark to the [Enable] checkbox.

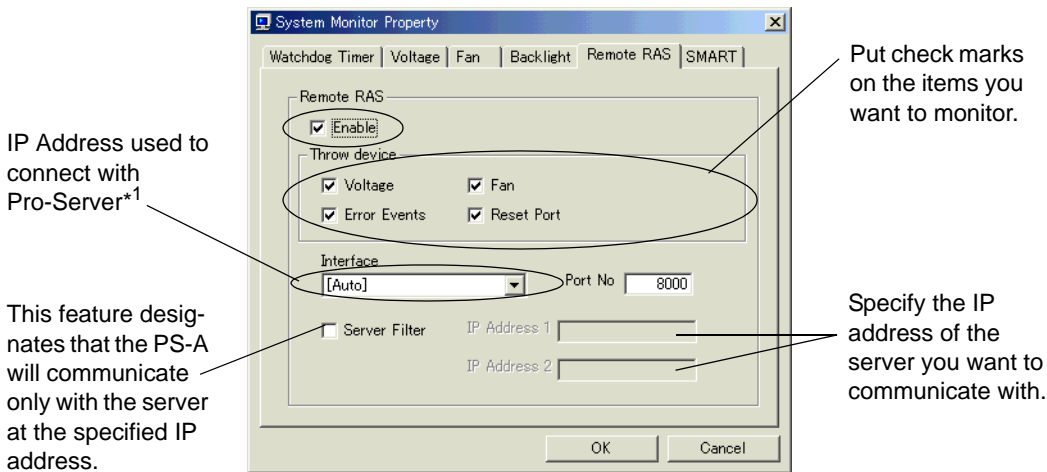

The Remote RAS feature is now enabled.

NOTE

- In order to actually activate the Remote RAS feature, you are required to start up the System Monitor (PSA_Smon.exe) within the PS-A.

*1 When allocating 2 or more IP Addresses to the PS-A unit, [Auto] cannot be selected. Enter settings that allow the reading of a fixed IP Address from a DHCP server. For details, contact your company's network administrator.

■ Setting Up the Server PC

- (1) Start up the Pro-Studio.
- (2) Register the PS-A you want to include in the network to the network station, and edit the participant stations.

SEE → *Pro-Server with Pro-Studio for Windows Operation Manual*

NOTE

- When using the Pro-studio's [Find Stations] command to register the PS-A to the network station, the System Monitor should be activated with the Remote RAS feature enabled in the PS-A.
- (3) Select [PL, PS-A, PS-B] for the PLC type on the network station editing.
 - (4) When registering the symbol, refer to the List of Device Address for the symbol that can be registered.

NOTE

- You are not required to transfer the network project file created with the Pro-Studio to the client PS-A.

5.4.4 Read and Write of the System Monitor/RAS Feature

The read/write operation of the operating conditions of the client PS-A and System Monitor/RAS feature can be performed from the server PC via the Pro-Server.

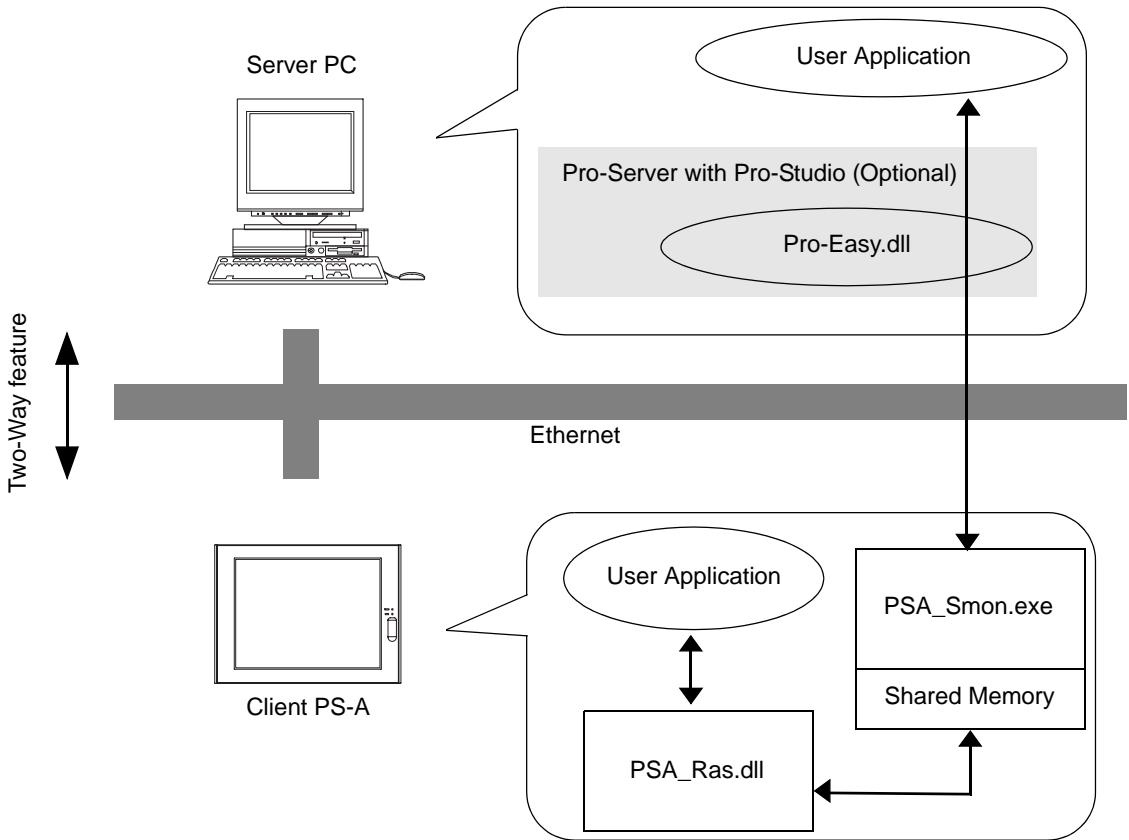

- The status of the System Monitor/RAS feature is stored in the shared memory for which device address is assigned.

SEE →

■ *List of Device Addresses (page 5-20) /*

■ *Bit Assign of Error Event, and Error Mask (page 5-21)*

- The status of the System Monitor/RAS feature is transferred to the Pro-Server via Ethernet from the PSA_Smon.exe. The RAS feature including voltage, FAN, and temperature can be monitored by monitoring the device addresses assigned from the Pro-Studio.
- The user applications in the server PC monitors the RAS feature through the Pro-Easy.dll program provided from the Pro-Server.
- The client PS-A shares the data with the user applications on the server PC by using the shared memory. The data transfers on both sides are processed via the PSA_Ras.dll and Pro-Easy.dll programs.
- The client PS-A can be shut down and re-started by writing specific value to the software reset port.

NOTE

- For the details of Read/Write to the devices and access procedures, refer to the “List of Device Addresses” below.

■List of Device Addresses

Device	Device Type	Device Symbol	Read/Write	Bit Access	16-bit Access	32-bit Access		
+3.3V Voltage* ¹	WORD	VLT	Read	-	VLT0	-		
+5V Voltage* ¹	WORD				VLT1			
+12V Voltage* ¹	WORD				VLT2			
-12V Voltage* ¹	WORD				VLT3			
Number of Revolution of CPU FAN * ²	WORD	FAN			FAN0			
Number of Revolution of Power FAN * ²	WORD				FAN2			
Number of Revolution of System FAN * ²	WORD				FAN1			
Error Event	WORD	ERR			ERR00-ERR0E	ERR0		
Internal Memory Area * ³	WORD	LS			Read/Write	LS00000-LS0000F to LS02550-LS0255F	LS0000 to LS0255	LS0000 to LS0254
Shared Memory	WORD	PL				PL00000-PL0000F to PL02550-PL0255F	PL0000 to PL0255	PL0000 to PL0254
Software Reset Port * ⁴	WORD	RST	Read/Write	-	RST0	-		
Error Mask * ⁵	WORD	ERRM	Read	ERRM00-ERRM0E	ERRM0	-		

IMPORTANT

- When “Forced Shutdown” or “Forced Reboot” is written to the device address, the system automatically shuts down/restarts the operation system without prompting the confirmation for saving the data on current applications.

Take extra cautions when performing write operation in order to avoid accidental data loss.

Value to be Written		Operation
Decimal Number	Hexadecimal Number	
1	0001	Shutdown
2	0002	Reboot
257	0101	Forced Shutdown
258	0102	Forced Reboot

- *1 When monitoring the voltage with the device monitor, the unit is “mV”.
- *2 When monitoring the voltage with the device monitor, the unit is “rpm”.
- *3 Used for the system to read/write the data and perform monitoring operation.
- *4 Shuts down and restarts the operation system on the client PS-A.
- *5 Indicates the error event that is being monitored by the PS-A.

■ Bit Assign of Error Event, and Error Mask

Device Name	Item	Bit
Error Event	+3.3V Voltage Error	ERR00
	+5V Voltage Error	ERR01
	+12V Voltage Error	ERR02
	-12V Voltage Error	ERR03
	CPU FAN Error	ERR04
	Power FAN Error	ERR05
	System FAN Error	ERR06
	Watchdog Timer Error	ERR07
	Backlight Error	ERR08
	SMART Error	ERR09
Error Mask	+3.3V Voltage Error	ERRM00
	+5V Voltage Error	ERRM01
	+12V Voltage Error	ERRM02
	-12V Voltage Error	ERRM03
	CPU FAN Error	ERRM04
	Power FAN Error	ERRM05
	System FAN Error	ERRM06
	Watchdog Timer Error	ERRM07
	Backlight Error	ERRM08
	SMART Error	ERRM09

■ Error Messages

This section describes the error messages of the Pro-Server that are displayed for the errors caused during device read/write operations. The following table lists the error codes for the RAS feature.

Error Code		Error Message
Decimal Number	Hexadecimal Number	
9530	253Ah	RAS Initialization Error
9531	253Bh	Command not supported.
9532	253Ch	Access type not supported.
9533	253Dh	Read/Write type not supported.
9534	253Eh	Access to the device rejected.
9535	253Fh	Value setting to the device/retrieval failed.
65535 (No Code)	ffffh	Returned when read/write of invalid values or unsupported device is performed for Voltage, Temperature, and number of revolution of the FAN.

SEE → For error messages other than listed above, refer to “Pro-Server with Pro-Studio for Windows Operation Manual”.

5.4.5 Restrictions

The following table lists the features of Pro-Server that are supported by the PS-A. For the details of each feature, refer to “Pro-Server with Pro-Studio for Windows Operation Manual”.

Pro-Server Feature	O: Supported X: Not Supported
DDE Feature	O
Simplified DLL Feature (ProEasy.dll)	Listed Separately
OPC Server Interface	O
SRAM Backup Data	X
Action Feature	X
Distribution Feature	X
Data Viewer	O*1
VBA Feature Assist	O
Device Data Backup/Restore Feature	O
Capture Screen Save Feature	X
Security Feature	O
Device Monitor	O
Status Monitor	X
Read Time Measurement	O

*1 Pro-Server with Pro-Studio Ver.4.0 or higher is required.

<Available Simplified DLL Features>

- Direct Read Feature
- Direct Write Feature
- Cache Read Feature
- Retrieval of Multithreading Handle
- Release of Multithreading Handle
- Loading of Network Project File
- Error Code String Conversion.
- Station Status Readout Feature
- Initialization of Simplified DLL
- Termination of Simplified DLL

NOTE

- Note that the PS-A-supported OS and features supported by Pro-Server are different.
- When using the PS- A's Remote RAS feature together with Pro- Server, be sure to select different port numbers.

5.5 Remote Shutdown Feature

The Remote Shutdown feature allows the user to shut down and/or restart the PS-A from the server PC via the network when the Pro-Server is not installed to the system. The installer of this application is included on the accessory CD-ROM (\Utility\Shutdown).

When the installer is started, you are asked to select the application for server or the client. Select the desired application, and follow the instruction on the screen to complete the installation.

File Name	Folder (Same for both Windows® XP and Windows® 2000)
PSClt.exe	C:\Proface\Shutdown\Client
RSSvr.exe	C:\Proface\Shutdown\Server

SEE →

4.1.1 Software (page 4-2)

NOTE

- For the operation procedure of this feature, refer to the online help of the Remote Shutdown Application.
- Both applications (for server and client) can be installed on the PS-A to achieve self-control system. In such a case, however, the PS-A should be connected to a network.

Memo

6



Maintenance and Inspection

1. Regular Cleaning
2. Changing the PS-A Backlight
3. Periodic Inspection Items

6.1 Regular Cleaning

6.1.1 Cleaning the Display

⚠ CAUTION

⊘ Do not clean the unit with thinner, organic solvents, or strong acids.

When the display surface or frame become dirty, use a soft cloth moistened with neutral detergent to wipe away any dust or stains.

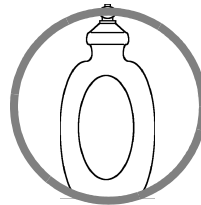

Neutral detergent

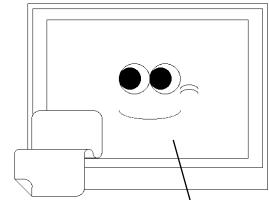

Display

Do not use sharp or hard objects, such as a mechanical pencil or screwdriver, to push on the display. This could damage the unit.

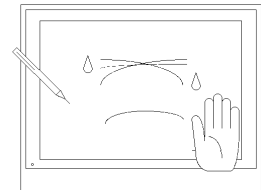

Use the screen protection sheet when using the PS-A in extremely dirty or dusty areas.

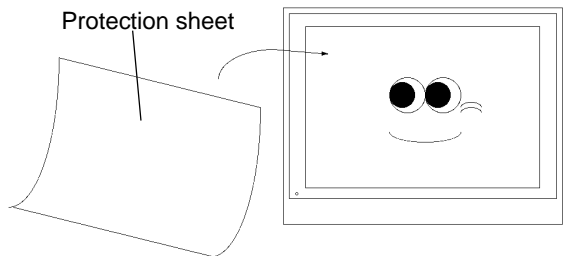

6.1.2 Installation Gasket Replacement

The moisture resistant gasket protects the PS-A and improves its water resistance. For instructions on installing the PS-A's gasket,

SEE → 2.2.2 *Installation Procedures (page 2-11)*

IMPORTANT

- A gasket which has been used for a long period of time may have scratches or dirt on it, and could have lost much of its water resistance. Be sure to change the gasket periodically (or when scratches or dirt become visible).

6.2 Changing the PS-A Backlight

The PS-A's backlight can be changed after it wears out. The corresponding backlight model number is CA3-BLU15-01. The steps involved are outlined below.

IMPORTANT

- If the backlight or the display unit is damaged, the screen display will go out. Even if the screen goes out, however, there is a possibility that the touch panel is still operating correctly. Therefore, since any type of touch panel contact could have an unexpected or dangerous effect or result, be sure not to touch the screen when this condition occurs.

⚠ WARNING

- ❗ Whenever changing the backlight, be sure the PS-A's power cord has been disconnected and that the unit is cooled down.
- ❗ When the PS-A's power cord is connected and the PS-A is ON, high voltage runs through the wires in the backlight area do not touch them!
- ❗ When the PS-A's power has just been turned OFF, the backlight area is still very hot! Be sure to wear gloves to prevent being burned.
- ❗ The backlight is very fragile. Do not touch the glass tube directly or try to remove its power cord. If the glass tube breaks you may be injured.
- ❗ Do not try to replace the backlight while the PS-A is installed in a cabinet or panel. Remove the PS-A first, then begin the backlight replacement procedures.

Follow the steps given below to change the PS-A's backlight. Be sure to wear cotton gloves when performing this work to prevent burns. Also, remove the PS-A from its installation panel, and place it face down (as shown below) when performing this work.

- (1) Unplug the PS-A's power cord from the main power supply.

IMPORTANT

- Be sure to perform the backlight changeover on a flat, level surface. This will prevent damage to the PS-A unit and the accidental cutting of any of its power cord.

- (2) Remove the PS-A's rear cover.

SEE →

2.1.1 Removing the PS-A Unit's Cover (page 2-2)

- (1) Insert a screwdriver into the two holes (points) shown below, and remove the backlight attachment screws (1 per hole).

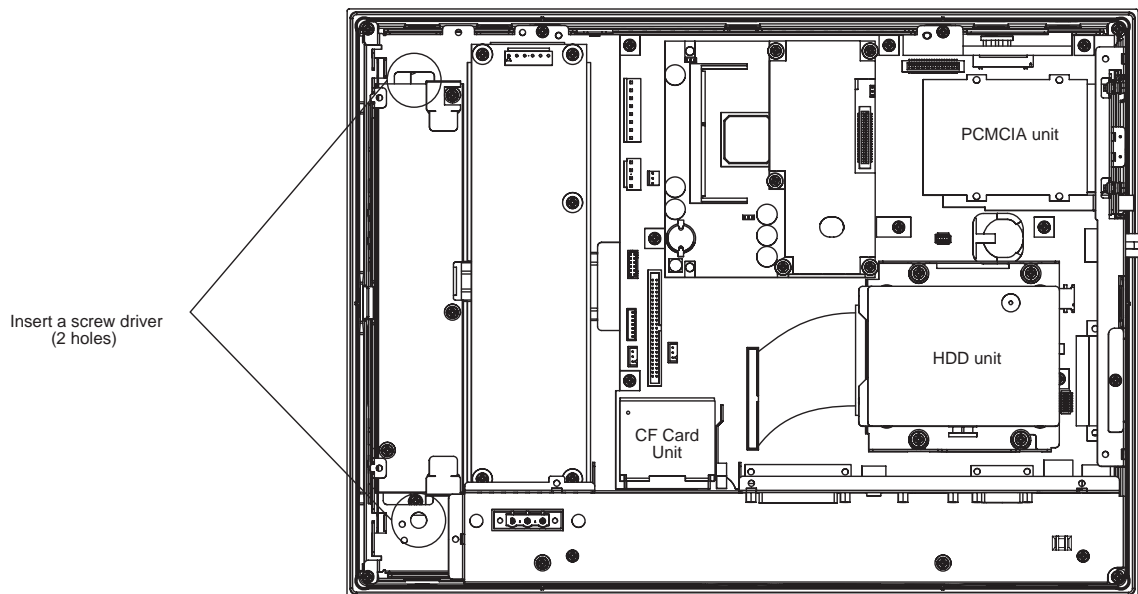

- (2) Remove the cable from the cable clamp, and detach the cable from the backlight connector on the inverter board.

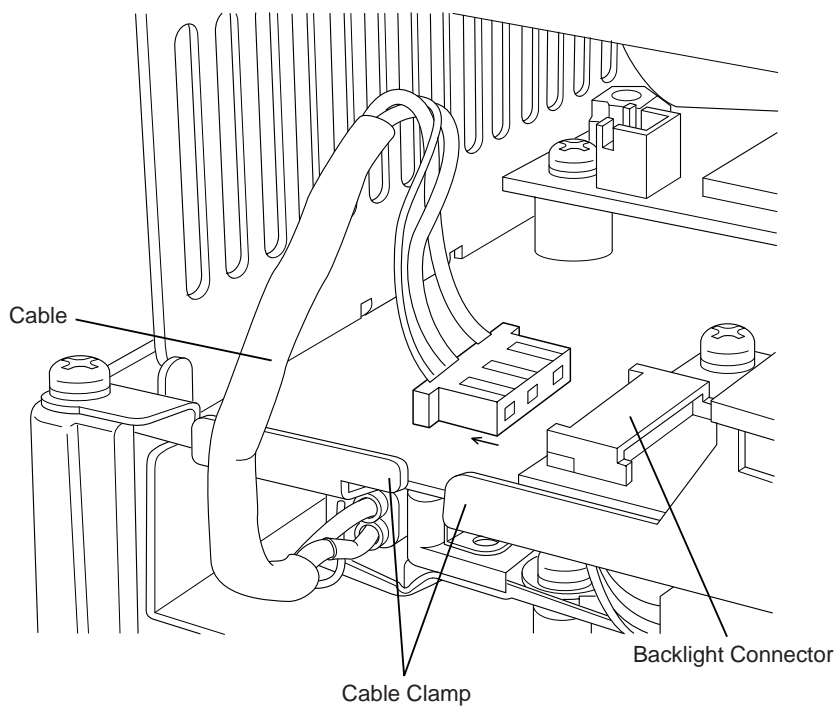

- (3) Pull out the cable in the direction shown by the arrow. The backlight unit detaches from the backlight unit insertion point.

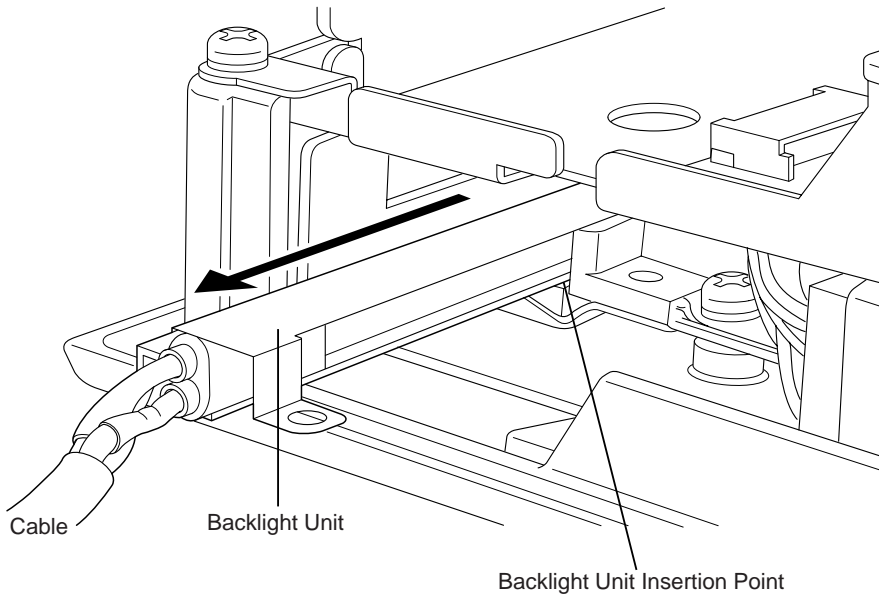

IMPORTANT • The entire backlight unit should be changed, not just the backlight.

- (4) Insert the new backlight unit into the backlight holder.
- (5) Re-attach the cable to the backlight connector (opposite of step (6)), and secure the cable in position using the cable clamp (opposite of step (5)).

IMPORTANT • Be sure the cable is inserted completely into the backlight connector. Failure to do so may cause arcing, which can damage the connector.

- Be sure to always change both of the PS-A backlights at the same time.

- (6) Secure both backlights in place using the backlight screw (opposite of step (4)). The necessary torque is 0.147N•m (1.5kgf•cm).
- (7) Replace the rear cover and secure it in place using the five (5) attachment screws.

IMPORTANT • The cable clamp is used to prevent the cable from being caught inside in the PS-A unit and possibly damaged. Be sure to insert the cable in the cable clamp around the cable before replacing the rear cover.

6.3 Periodic Inspection Items

Be sure to inspect the PS-A periodically to ensure it is in good working condition.

■ Ambient environment check

Is the ambient temperature within the specified range ?

When using HDD	When not using HDD
+5 to +40°C	0 to +40°C

- Is the ambient humidity within the specified range (10%RH to 85%RH) ?
- Is the atmosphere free of corrosive gas ?

■ Electrical specifications check

- Is the voltage adequate (DC19.2V to DC28.8V) ?

■ Installation check points

- Are all connection cables firmly connected ?
- Are any bolts or screws loose ?
- Are there any flaws or tears in the moisture resistant gasket ?

■ Display check

- Is the display bright enough ?

NOTE

- When the PS-A's backlight needs to be replaced, please contact your nearest authorized service center for prompt service.

Memo

7 | Specifications

1. General Specifications
2. Performance Specifications

7.1 General Specifications

7.1.1 Electrical Specifications

Rated Voltage	DC24V
Voltage Supply Range	DC19.2V to DC28.8V
Allowable Voltage Drop	1 cycle or less (pause occurrences must be more than 1 second apart)
Power Consumption	90VA or less
Voltage Endurance	AC1000V 20mA for 1 minute (between charging and FG terminals)
Insulation Resistance	10MΩ or higher at DC500V (between charging and FG terminals)

7.1.2 Environmental Specifications

Ambient Operating Temperature	+5 °C to +40 °C (When Using HDD) 0 °C to +40 °C (When NOT Using HDD)	
Storage Temperature	-10 °C to + 60 °C	
Ambient Humidity	10%RH to 85%RH (Non condensing, wet bulb temperature : 29°C or less)	
Storage Humidity	10%RH to 85%RH (Non condensing, wet bulb temperature : 29°C or less)	
Air Purity (Dust)	Free of dust	
Pollution Degree	Pollution Degree 2	
Corrosive Gases	Free of corrosive gases	
Vibration Resistance	When using HDD	4.9m/s ² at 10Hz to 25Hz in X, Y, Z directions for 30 minutes
	When NOT using HDD	19.6m/s ² at 10Hz to 25Hz in X, Y, Z directions for 30 minutes
Noise Immunity (Impulse Noise)	Noise Voltage : 1500V (via noise simulator) Pulse Duration : 50ns, 500ns, 1μs Rise Time : 1ns	
Noise Immunity (First transient burst noise)	Power Line : 2kV IEC 61000-4-4 COM Port : 1kV IEC 61000-4-4	
Electrostatic Discharge Immunity	4kV IEC 61000-4-2	

IMPORTANT

- When using any of the PS-A's optional devices, be sure to check that device's specifications for any special conditions or cautions that may apply to its use.
- Be aware that not only does the Hard Disk have a fixed lifetime, but that accidents can always occur. Therefore, be sure to back up your Hard Disk's data regularly, or prepare another Hard Disk unit that can be used for backup.
- The Hard Disk lifetime may be reduced due to unforeseen environmental factors, however, generally speaking, the disk should last for 20,000 hours (of operation) or approximately 5 years, whichever comes first at an operating temperature of 20°C and 333 hours of operation per month. (HDD access frequency of 20% or less)
- Using the Hard Disk in an environment that is excessively hot and/or humid will shorten the disk's usage lifetime. A wet bulb temperature of 29°C or less is recommended. This is equivalent to the following data.

Temperature	Humidity
at 35°C	no higher than 64%RH
at 40°C	no higher than 44%RH

- In order to extend the lifetime of the hard disk, Pro-face recommends you set the Windows [Control panel]-[Power Management option]-[Turn off hard disks] selection to turn the hard disk off when the unit is not being operated. A setting of 5 minutes is recommended.

7.1.3 Structural Specifications

Grounding	100Ω or less, or your country's applicable standard
Ratings ^{*1}	Equivalent to IP65f (JEM 1030) (When Not Using front-face USB Port unit) Design Type: Modular Installation method: Panel / VESA Arm
Cooling Method	Natural Cooling
Weight	Approx. 6.0kg (13.2lb)
Dimensions (W x H x D)	395 mm [15.55 in.] x 294 mm [11.57 in.] x 60 mm [2.36 in.]

*1 The front face of the PS-A unit, installed in a solid panel, has been tested using conditions equivalent to the standard shown in the specification . Even though the PS-A unit's level of resistance is equivalent to this standard, oils that should have no effect on the PS-A can possibly harm the unit. This can occur in areas where either vaporized oils are present, or where low viscosity cutting oils are allowed to adhere to the unit for long periods of time. If the PS-A's front face protection sheet becomes peeled off, these conditions can lead to the ingress of oil into the PS-A and separate protection measures are suggested. Also, if non-approved oils are present, it may cause deformation or corrosion of the front panel's plastic cover. Therefore, prior to installing the PS-A, be sure to confirm the type of conditions that will be present in the PS-A's operating environment.

If the installation gasket is used for a long period of time, or if the unit and its gasket are removed from the panel, the original level of the protection cannot be guaranteed. To maintain the original protection level, Pro-face recommends that you replace the installation gasket regularly.

7.2 Performance Specifications

7.2.1 Performance Specifications

CPU		Eden™ ESP6000 667MHz (VIA)		
DRAM(SO DIMM)		DIMM Socket 1: 128MB/256MB		
BIOS		Phoenix - FirstBIOS (Phoenix Technologies Co.)		
Graphics		XGA (1024 x 768 dots)		
Video Memory		UMA Type		
Touch Panel	Type	Resistive Film (Analog)		
	Resolution	1024 x 1024		
	Interface	USB		
Interface	Serial	COM1	D-sub 9 pin male (RI/+5V switch poss.)	
		COM2	D-sub 9 pin male (RS-232C/RS-422/RS-485 switch poss., RI/+5V switch poss.)	
	Printer	Complies with Centronics Standards (ECP/SPP/EPP equivalent) (D-Sub 25 pin, female)		
	Keyboard	PS/2 Interface (mini DIN 6 pin, female) rear 1 port		
	Disk	IDE I/F	Master	2.5inch HDD I/F
			Slave	CF Card I/F
	USB	USB 1.1 compatible front 1 port and rear 2 ports		
	Ethernet	IEEE802.3 Standards (auto change to 10 Base-T/100 Base-TX) side 1 port		
	PCMCIA	Type II side 2 ports		
	Sound	SPEAKER OUT rear 1 port (standard type AUDIO jack)		
CD-ROM Drive	CD-ROM Drive I/F rear 1 port			

7.2.2 Display Functions

Display Type	TFT Color LCD (15 inch)
Pixel Density	1024 x 768 pixels
Dot Pitch	0.297 x 0.297mm
Effective Display Area	304.1 x 228.1mm
Display Colors	260000 Colors
Backlight's Life Span	CFL (Replaceable) More than 50,000 hours at an ambient temperature of 25°C. (Until the backlight_fs brightness dims to half of the original level.)
Touch Panel Brightness Adjstment	4 Steps (Adjust using Windows® Control Panel)
Contrast Control	Not Possible

7.2.3 Clock Accuracy

Clock Accuracy	±180 seconds/month
----------------	--------------------

The clock built into the PS-A (RTC) has a slight error. The error is ±180 seconds per month when the PS-A is turned off and kept under normal temperature. However, the error may become as large as ±300 seconds per month depending on the temperature differences and years of service. If using the PS-A in the system in which clock accuracy is vital, be sure to adjust the clock periodically.



Appendices

1. Hardware Configuration
2. List of Optional Devices

A.1 Hardware Configuration

A.1.1 I/O Map

Address	AT System Device	System Device
0000H-001FH	DMA controller (8237)	
0020H-003FH	Interrupt controller (8259A)	
0040H-005FH	System timer (8254)	
0060H-006FH	Keyboard controller	
0070H-007FH	Real time clock, NMI mask	
0080H-009FH	DMA page register	
00A0H-00BFH	Interrupt controller 2 (8259A)	
00C0H-00DFH	DMA controller 2 (8237)	
00F0H-00FFH	Numeric data processor	
01F0H-01FFH	Hard disk (IDE)	
0290H-0297H	Reserved	System monitor
0378H-037FH	Parallel Port	
02F8H-02FFH	Serial port 2 (COM2): General use	
03B0H-03BBH	Video controller (VGA)	
03C0H-03DFH	Video controller (VGA)	
03F8H-03FFH	Serial port 1 (COM1): General use	

A.1.2 Memory Map

Frame Buffer	MAXMEM
Expansion Memory	MAXMEM Frame Buffer Size *1
Sistem BIOS	1MB
Expansion ROM Area	F000:0000
PXE BIOS, VGA BIOS	D400:0000
Video RAM	C000:0000
Conventionally	A000:0000
	0000:0000

*1 Depending on the BIOS Setting [Advanced Chipset Feature] [Frame Buffer Size] setting value , Memory range may differ. The default setting is 16MB.

SEE → 3 System Setup (page 3-1)

A.1.3 Interrupt Map

■ Hardware Interrupt List

	Description
NMI	Parity Error or I/O Channel Check
IRQ 0	Timer (in the Chipset)
1	Keyboard
2	Cascade from Controller 2
3	Serial Port 2 (COM2): General Use Port
4	Serial Port 1 (COM2): General Use Port
5	Available for users *
6	Available for users *
7	Available for users *
8	Real Time Clock
9	Available for users *
10	Available for users *
11	Available for users *
12	Available for users *
13	Numeric Data Processor
14	Hard Disk (IDE)
15	CD-ROM Drive

IMPORTANT

- The "*" mark indicates that, depending on the customer's settings, the following devices are automatically allocated as Plug and Play devices.

- Display Controller
- SMBus Controller
- Multimedia Device
- Network Controller
- USB Controller

■ DMA Channel List

	Description	
DMA 0		For 8-bit transmission
1		
2		
3		For 16-bit transmission
4	Cascade to controller 1	
5		
6		
7		

A.2 List of Optional Devices

The following table lists the Digital Electronics Corporation's optional devices and commercial products used with the PS-A.

Product Name	Model	Description
DIM Module	PSA-SDR128	SO (DIMM) with capacity of 128 MB.
	PSA-SDR256	SO (DIMM) with capacity of 256 MB.
Mouse Emulator V2	PL-TD000	This software adds mouse and keyboard-like functionality to the Touch Panel.
HDD Unit	PSA-HD20	20 GB 2.5" HDD unit. (OS not included.)
CD-ROM Drive Unit	PSS-CD01	CD-ROM Drive Unit for development and maintenance use. (special connection cable is included with unit)
CF Card	CA3-CFCALL/64MB-01	TYPE1 CF Card (64MB)
	CA3-CFCALL/128MB-01	TYPE1 CF Card (128MB)
	CA3-CFCALL/256MB-01	TYPE1 CF Card (256MB)
	CA3-CFCALL/512MB-01	TYPE1 CF Card (512MB)
CF Card Adaptor	GP077-CFAD10	CF Card Adaptor for a PCMCIA connector
Screen Protection Sheet	CA3-DFS15-01	Disposable overlay sheets for display face protection and stain resistance. Touch panel senses User's touch through sheet. (5sheets / set)
Backlight	CA3-BLU15-01	Spare backlight for maintenance.
Installation Gasket	CA3-WPG15-01	Used to prevent moisture from entering into the PS-A's case from the front face. Same as original equipment gasket.
Installation Fasteners	CA3-ATFALL-01	Used to install the PS-A unit a panel. (4/set x 2)

Memo

Index

Symbols

4in1 Driver 4-6

A

Advanced BIOS Features 3-6

Advanced Chipset Features 3-9

Alarm Processing 5-2

API-DLL 4-7

Arm Attachment Screw Holes 1-5

Audio Driver 4-6

Automatic System Log-on Setup 4-10

B

Backlight Alarm 5-3

Backlight Brightness Adjustment (Bl Bright.cpl) 4-9

Backlight Control API-DLL file (PSA_BLC.DLL) 4-7

Backlight OFF Screen Saver (Backlight Control.scr).. 4-8

Bit Assign of Error Event, and Error Mask 5-21

Buzzer Output 5-4

C

CD-ROM Contents 4-2

CD-ROM Drive Interface Cover 1-5

CE Marking Notes 9

CF Card Installation and Removal 2-7

CF Card Interface Cover 1-5

Changing System Settings 4-11

Changing the PS-A Backlight 6-4

Cleaning the Display 6-2

Clock Accuracy 7-6

Connecting the Power Cord 2-15

Cooling Fan Rotation Alarm 5-3

D

Dip Switches 1-10

Display / Touch Panel 1-5

Display Functions 7-6

DMA Channel List App-4

E

Electrical Specifications 7-2

Environmental Specifications 7-2

Error Messages 5-12, 5-22

Error Monitoring 5-3

Essential Safety Precautions 2

Ethernet Interface 1-5

Event Viewer 5-14

Exit Without Saving 3-22

External Dimensions (with Installation Fasteners
installed) 1-13

F

Frequency/Voltage Control 3-21

Front Packing 1-5

G

General Specifications 7-2

Graphic Accelerator Driver 4-6

H

Hardware Interrupt List App-4

Hardware Reset Switch 1-5

I

I/O Map App-2

IDE Access Lamp 1-5

IDE HDD Auto-Detection 3-5

Information Symbols 5

Installation 2-2

Installation Caution 2-9

Installation Fasteners 1-14

Installation Gasket 2-11

Installation Gasket Replacement 6-3

Installation Location 2-10

Installation Positioning 2-9

Installation Procedures 2-11

Installing Drivers 4-6

Installing the PS-A Unit 2-9

Integrated Peripherals 3-12

Interfaces 1-7

Interrupt Map App-4

IRQ Resources 3-19

K

Keyboard Connector 1-5

Keyboard Emulator (Keyclick.exe) 4-8

L

LED Indicator 5-4

List of Device Addresses	5-20
List of Optional Devices.....	App-5
Load Fail-Safe Defaults.....	3-21
Load Optimized Defaults	3-22

M

Main Memory Installation.....	2-3
Memory Map.....	App-3

N

NFTS File System Conversion.....	4-11
----------------------------------	------

P

Package Contents.....	6
Panel Cut Dimensions	1-14
PCMCIA Interface.....	1-5
PCMCIA Unit Installation.....	2-4
Performance Specifications	7-5
Periodic Inspection Items	6-7
PnP/PCI Configurations	3-18
Pop-up Message Output	5-4
Power Input Terminal Block	1-5
Power Lamp LED.....	1-5
Power Management Setup.....	3-16
Power Supply Cautions	2-16
Power Voltage Alarm.....	5-3
Printer Connector.....	1-5
Printer Interface (LPT1)	1-12
Prior to Operating the PS-A Unit	1-2
PS-A	1
PS-A Internal View.....	2-3
PS-A Unit	1-13
PS-A Unit External Views and Dimensions	1-13
PS-A Unit Part Names and Features	1-5
PS-A Unit System Configuration	1-3

R

RAS	4-7
RAS Features.....	5-2
RAS Features: PSA_IOC.DLL.....	4-7
Rear Cover.....	1-5
Remote RAS	5-16
Remote Shutdown Feature	5-23
Removing the PS-A Unit's Cover.....	2-2

S

Save & Exit Setup	3-22
Screen Display ON/OFF Utility (DISP.EXE)	4-8

Index-2

Serial Interface	1-5
Serial Interface (COM1/COM2)	1-7
Setting Up an HDD with Pre-installed OS.....	4-4
Setting Up Your PS-A Unit	4-3
Setup Procedures	3-2, 4-3
Shared Memory Access: PSA_RAS.DLL.....	4-7
Software	4-2
Speaker Output Connector	1-5
Special Application Program Features	4-7
Standard CMOS Features.....	3-3
Structural Specifications.....	7-4
System File: Psamon.sys	4-8
System Monitor	5-2
System Monitor Setup.....	3-20
System Monitor/RAS Features.....	5-6
System Monitoring Program: PSA_Smon.exe.....	4-7
System Monitoring Property (PSA_Wps.exe)	5-7
System Monitoring Property Settings (PSA_Wps.exe).....	5-7
System Monitoring/RAS Applications: PSA_Smon.exe/ PSA_Wps.exe.....	4-7
System Monitoring: PSA_DLL.DLL.....	4-7
System Parameters	3-3
System Reset	5-4
System Shutdown	5-4

T

Table of Contents.....	11
Temperature Related.....	2-9
Touch Panel Alarm.....	5-3
Types of Monitoring.....	5-2
Types of Processing.....	5-4

U

UL/c-UL (CSA) Application Notes	8
Uninstalling Utility Software	4-9
Uninterrupted Power Supply System (UPS).....	4-11
USB 1.1 Driver.....	4-6
USB Cable Clamp Installation	2-5
USB Interface	1-4, 1-5

V

Vibration and Shocks	2-10
----------------------------	------

W

Watchdog Timer Timeup.....	5-3
When Using Windows® 2000/Windows® XP	4-10
Wiring the PS-A	2-15