



J1939 Driver

1	System Configuration.....	3
2	External Device Selection	4
3	Communication Settings	6
4	Setup Items	7
5	Cable Diagrams	10
6	Supported Devices.....	12
7	Device Code and Address Code.....	27
8	Error Messages.....	28

Introduction

This manual describes how to connect the Display and the External Device (target PLC).

In this manual, the connection procedure is described in the sections identified below:

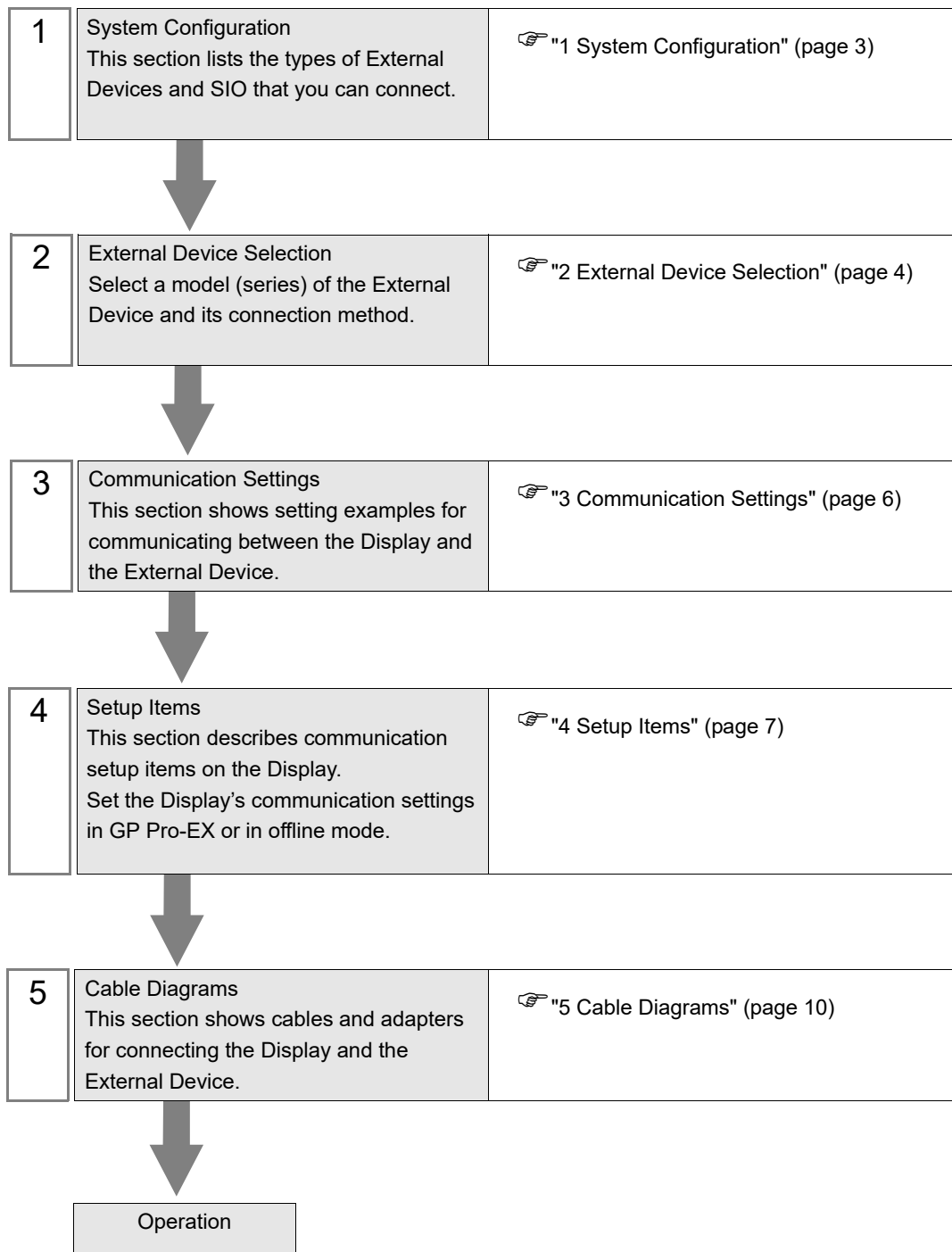

1 System Configuration

The following table lists system configurations for connecting J1939 standard External Device and the Display.

Series	CPU	Link I/F	SIO Type	Setting Example	Cable Diagram
J1939 compatible device		J1939 I/F	CAN / J1939 Bus	"Setting Example 1" (page 6)	"Cable Diagram1" (page 11)

- IMPORTANT**
- To use this driver, the J1939 unit (PFXZCHEUJ1) by Pro-face is required. For details on the J1939 unit, refer to the J1939 unit manual.
 - This driver conforms to SAE J1939 standardized by Society of Automotive Engineers (SAE). In addition, it does not correspond to J1939 extended standards such as NMEA2000 and ISOBUS.

■ Connection Configuration

- 1:n connection

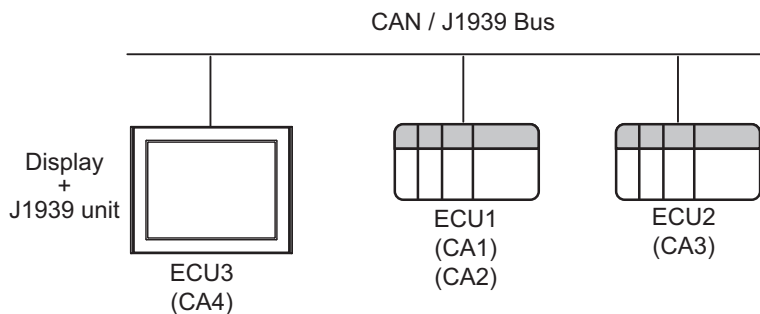

- NOTE**
- The maximum number of connected nodes for ECU is 30 nodes. ECU can have one or more CA addresses.
 - The Display is also set with ECU and CA addresses.
 - The communication destination is specified using the CA address.

2 External Device Selection

Select the External Device to be connected to the Display.

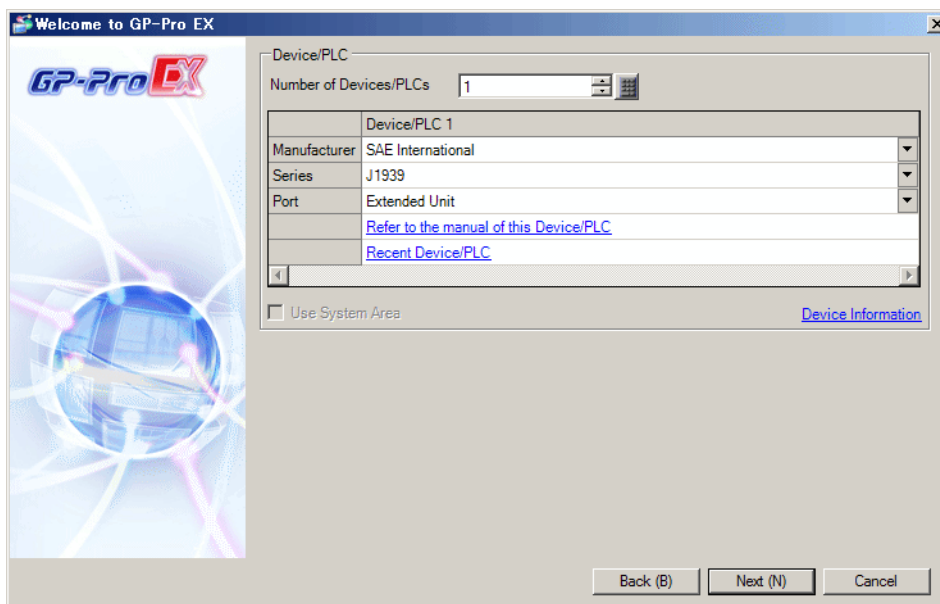

Setup Items	Setup Description
Number of Devices/PLCs	Enter an integer from 1 to 4 to define the number of Devices/PLCs to connect to the display.
Manufacturer	Select the manufacturer of the External Device to connect. Select "SAE International".
Series	Select the External Device model (series) and the connection method. Select "J1939". In System configuration, make sure the External Device you are connecting is supported by "J1939". ☞ "1 System Configuration" (page 3)
Port	Select the Display port to connect to the External Device.
Use System Area	This driver cannot be used.

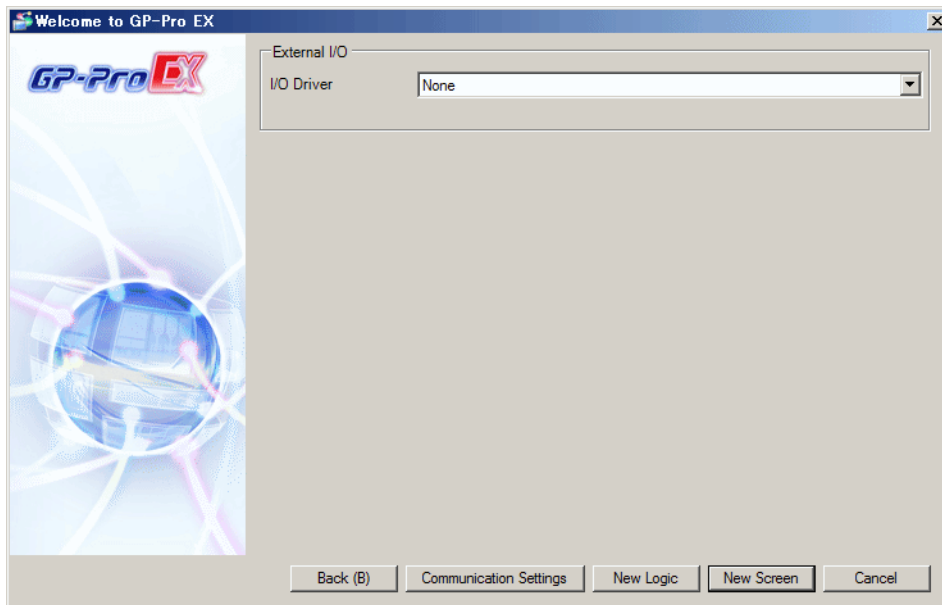

Setup Items	Setup Description
I/O Driver	Select "None".

3 Communication Settings

This section provides examples of communication settings recommended by Pro-face for the Display and the External Device.

3.1 Setting Example 1

■ GP Pro-EX Settings

◆ Communication Settings

To display the setup screen, from the [Project] menu, point to [System Settings] and select [Device/PLC].

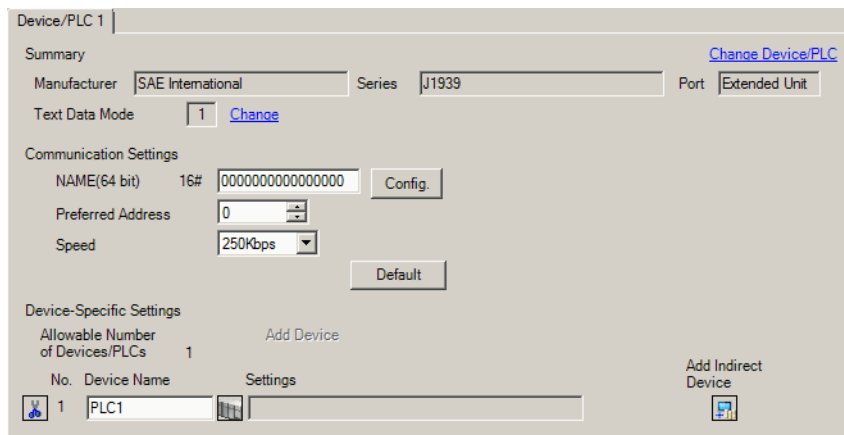

◆ Device Setting

To display the [Individual Device Settings] dialog box, from [Device-Specific Settings] in the [Device/PLC] window, select the external device and click [Settings]  .

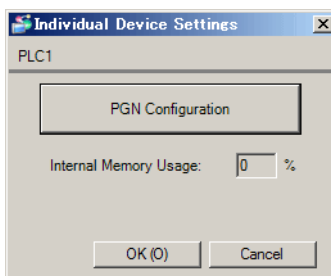

NOTE

- For [PGN Configuration], refer to the following.

 " ■ Device Setting" (page 8)

■ External Device Settings

For information, refer to the External Device manual.

4 Setup Items

Set up the Display's communication settings in GP Pro-EX or in the Display's offline mode.

The setting of each parameter must match that of the External Device.

 "3 Communication Settings" (page 6)

4.1 Setup Items in GP Pro-EX

■ Communication Settings

To display the setup screen, from the [Project] menu, point to [System Settings] and select [Device/PLC].

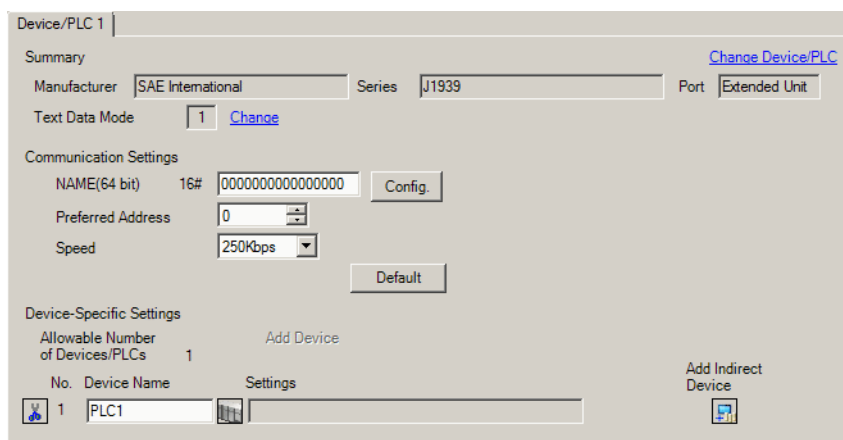

Setup Items	Setup Description
NAME(64bit)	Set the Display device name. The device name includes information such as the device type and device function, and manufacturer name. Set the device name following the J1939 address claim format. You can also set the device name in the dialog box that appears when you click [Config].
Preferred Address	Set the CA address (0 to 253) for the Display.
Speed	Select the communication speed between the External Device and Display. Select either [250 Kbps] or [500 Kbps].

NOTE

- Refer to the GP-Pro EX Reference Manual for Indirect Device.
Cf. GP-Pro EX Reference Manual "Changing the Device/PLC at Runtime (Indirect Device)"

■ Device Setting

To display the [Individual Device Settings] dialog box, from [Device-Specific Settings] in the [Device/PLC] window, select the external device and click [Settings]  .

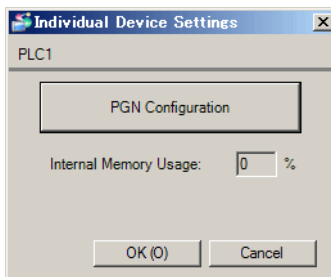

Setup Items	Setup Description
PGN Configuration	Register and edit parameter group numbers (PGN). NOTE <ul style="list-style-type: none"> To use this driver, PGN must be registered.
Internal Memory Usage	Displays the usage rate of PGN registration memory on the Display. Register PGN so as not to exceed 100%.

4.2 Setup Items in Offline Mode

NOTE

- Refer to the Maintenance/Troubleshooting manual for information on how to enter offline mode or about the operation.
- Cf. Maintenance/Troubleshooting Guide "Offline Mode"
- The number of the setup items to be displayed for 1 page in the offline mode depends on the Display in use. Please refer to the Reference manual for details.

■ Communication Settings

To display the setting screen, touch [Device/PLC Settings] from [Peripheral Settings] in offline mode. Touch the External Device you want to set from the displayed list.

Comm.				
J1939				Page 1/1
Name(64bit)	16#	0000000000000000		
Preferred Address		253	▼	▲
Speed		250Kbps	▼	
Exit		Back		2019/04/26 14:50:02

Setup Items	Setup Description
NAME(64bit)	Displays the device name.
Preferred Address	Set the CA address (0 to 253) for the Display.
Speed	Select the communication speed between the External Device and Display. Select either [250 Kbps] or [500 Kbps].

5 Cable Diagrams

The following cable diagrams may be different from cable diagrams recommended by SAE International. Please be assured there is no operational problem in applying the cable diagrams shown in this manual.

- Please ground the FG pin of the External Device body. Use a grounding resistance of 100Ω 2mm^2 or thicker wire, or your country's applicable standard. Refer to your External Device manual for more details.

■ Recommended Connector and Cables

	Model No.	Manufacturer	Description
Recommended Cable Connector	XM3D-0921	<OMRON Co.>	DSUB 9-pin socket without termination resistance
	TSXCANKCDF180T	<Schneider Electric>	Straight connector with terminal selector switch attached
	TSXCANKCDF90T TSXCANKCDF90TP	<Schneider Electric>	Right-angled connector with terminal selector switch attached.
	VS-09-BU-DSUB/CAN	<PHOENIX CONTACT>	Connector with terminal block attached with terminal selector switch attached
	SUBCON-PLUS-CAN/AX	<PHOENIX CONTACT>	Straight connector with terminal selector switch attached
	SUBCON-PLUS-CAN/PG SUBCON-PLUS-CAN	<PHOENIX CONTACT>	Right-angled connector with terminal selector switch attached
Recommended Transfer Cable	TSX CAN CA50 TSX CAN CA100	<Schneider Electric>	Cable for CANopen (IEC60332-1) 50 m/100 m
	TSX CAN CB50 TSX CAN CB100	<Schneider Electric>	UL-authenticated cable for CANopen (IEC60332-2) 50 m/100 m

Cable Diagram1

Display (Connection Port)	Cable	Notes
SP5000 series (GMU)	J1939 unit by Pro-face141414 PFXZCHEUJ1 + Recommended cable	

NOTE

- The communication distance is 40 m for 500 Kbps and 250 Kbps.

- 1:1 connection

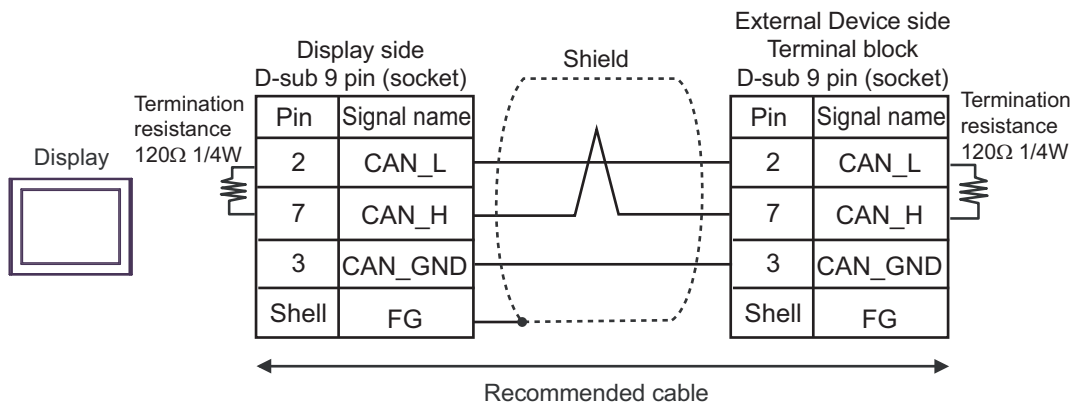

- 1:n connection

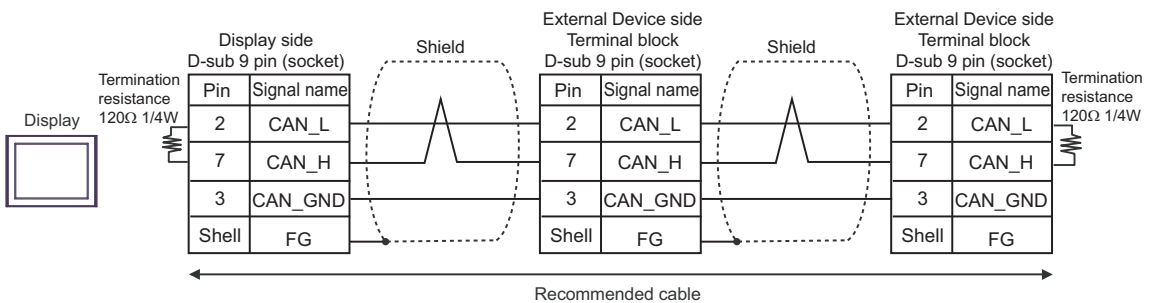

IMPORTANT

- Add termination resistance (120Ω 1/4W) at both ends of the cable connections as shown above.

6 Supported Devices

The following table shows the range of supported device addresses. Please note that the actually supported range of the devices varies depending on the External Device to be used. Please check the actual range in the manual of your External Device.

Device	Bit Address	Word Address	32bits	Notes
BYTE Array	<CA>_<PGN>.ARRAY[0].0 - <CA>_<PGN>.ARRAY[n-1].7	<CA>_<PGN>.ARRAY[0] - <CA>_<PGN>.ARRAY[n-1]	-	*1 *2
BYTE	<CA>_<PGN>.<SPN>.0 - <CA>_<PGN>.<SPN>.7	<CA>_<PGN>.<SPN>	-	*2 *3 *4
SINT				
USINT				
WORD	<CA>_<PGN>.<SPN>.00 - <CA>_<PGN>.<SPN>.15	<CA>_<PGN>.<SPN>	-	*2 *4 *5
INT				
UINT				
DWORD	<CA>_<PGN>.<SPN>.00 - <CA>_<PGN>.<SPN>.31	<CA>_<PGN>.<SPN>	L / H	*2 *4 *6
DINT				
UDINT				
REAL	-	<CA>_<PGN>.<SPN>	-	*2 *7
STRING	-	<CA>_<PGN>.<SPN>	-	*2 *8

- *1 This device makes the entire PGN accessible as a byte array. Use when working with data across multiple SPN at the same time. n indicates the PGN data length in bytes.
- *2 The setting range is as follows.
 CA: Control Address (0 - 255)
 PGN: Parameter Group Number (0 - 262143, 18 bit addressing)
 SPN: Suspect Parameter Number (0 - 516096, 19 bit addressing)
- *3 Use this device when the SPN data length is set from 1 to 8 bits.
- *4 Unused bits are set to 0.
- *5 Use this device when the SPN data length is set from 9 to 16 bits.
- *6 Use this device when the SPN data length is set from 17 to 32 bits.
- *7 Use with 32-bit floating point numbers.
- *8 The maximum number of characters for a STRING device is 1785.

NOTE

- For the meaning of icons in the table, refer to the precautions in the manual notation.
 "Manual Symbols and Terminology"
- Even if you use a nonexistent address, a read error may not display. In these cases, "0" becomes the value for the read data. Note that writing to a nonexistent address displays a write error.

■ Internal Device for J1939 unit

The following are internal registers. These are supported as standard. (Not required to register in the PGN list.)

Name	Data Type	Bit Address	Word Address	Read/Write	Notes
-	BYTE Array	999_0.ARRAY[0].0 - 999_0.ARRAY[n-1].7	999_0.ARRAY[0] - 999_0.ARRAY[n-1]	Read	Byte array for internal device
0 (Assigned Address)	BYTE	999_0.0.0 - 999_0.0.7	999_0.0	Read	Address assigned to the Display
1 (NAME#16)	STRING	-	999_0.1	Read	
2 (Baudrate)	WORD	999_0.2.00 - 999_0.2.15	999_0.2	Read	Current communication speed
3 (Active Address List1)	DWORD	999_0.3.00 - 999_0.3.31	999_0.3	Read	Active address in the network ^{*1*2}
:	:	:	:		
10 (Active Address List8)	DWORD	999_0.10.00 - 999_0.10.31	999_0.10	Read	
11 (J1939 FW Version)	DWORD	999_0.11.00 - 999_0.11.31	999_0.11	Read	Firmware version of J1939 unit
12 (Error Num)	WORD	999_0.12.00 - 999_0.12.15	999_0.12	Read	Error count
13 (Error Status 1)	WORD	999_0.13.00 - 999_0.13.15	999_0.13	Read	Error code 1 ^{*3}
:	:	:	:	Read	:
22 (Error Status 10)	WORD	999_0.22.00 - 999_0.22.15	999_0.22	Read	Error code 10 ^{*3}
23 (Error Reset)	WORD	999_0.23.00 - 999_0.23.15	999_0.23	Read/Write	Error reset ^{*4}

*1 The update interval for the Active Address List is 1 second. Therefore, read the address list regularly.

*2 The bit position corresponding to the Active Address turns ON.

Bit List No.	15	14	13	12	11	10	9	8	7	6	5	4	3	2	1	0
1	15	14	13	12	11	10	9	8	7	6	5	4	3	2	1	0
	31	30	29	28	27	26	25	24	23	22	21	20	19	18	17	16
2	47	46	45	44	43	42	41	40	39	38	37	36	35	34	33	32
	63	62	61	60	59	58	57	56	55	54	53	52	51	50	49	48
:	:	:	:	:	:	:	:	:	:	:	:	:	:	:	:	:
8	239	238	237	236	235	234	233	232	231	230	229	228	227	226	225	224
	-	-	253	252	251	250	249	248	247	246	245	244	243	242	241	240

*3 Refer to " ■ Error Code (RHxx133)" (page 29) for details on error codes.

*4 Setting 1 to the device clears Error Num (999_0.12) and Error Status (999_0.13 to 999_0.23), and turns off the ERR LED on the J1939 unit. The value is always 0 when reading the device.

◆ Setup Items in the Add Tag Dialog Box

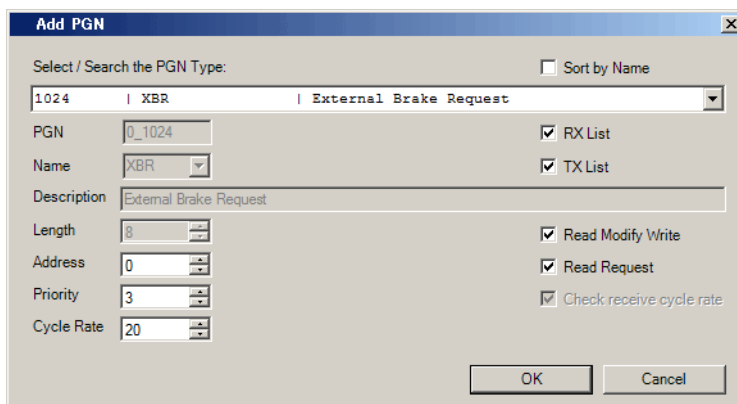

Setup Items	Setup Description
Address	The CA address of the External device.
Priority	The priority of parameter group (PG).
Cycle Rate	Set the output frequency (ms) for read request and write request. If remove the check for read request, set the sending cycle of the External Device parameter group (PG). If the cycle is 0, the command is issued on the Display screen update cycle or D-Script operation cycle.
Read Modify Write	Select this check box to enable read-modify-write. The parameter group (PG) consists of multiple suspect parameters (SP), but communication is performed in parameter group (PG) units. When writing to a suspect parameter (SP) with read-modify-write enabled, after reading the parameter group (PG) unit, only the area corresponding to the suspect parameter is updated and written back to the parameter group. When this check box is cleared, the previously written value is used and only the area corresponding to the suspect parameter is updated then written to the parameter group. When the Display is rebooted or enters offline mode, the previously written value is reset to 0.
Read Request	Either prevents or allows output of read request. Select this check box to allow output of read request. When preventing the output of read commands, the read value is not updated until the External Device issues a write request. Additionally, even if you prevent output of read request, if read-modify-write is enabled, the read request is issued immediately before the write request is issued.
Check receive cycle rate	Either prevents or allows check receive cycle rate. To allow the check receive cycle rate, clear the [Read Request] check box and set the time in [Cycle Rate]. The check receive cycle rate monitors whether the parameter group (PG) sent by the External Device can be received within twice the time set in the [Cycle Rate]. If the parameter group (PG) cannot be received within the monitoring period, an error message (RHxx133) appears on the Display and the ERR LED lights up on the J1939 unit.

NOTE

- If the [Cycle Rate] is from 1 to 250 ms, the monitoring time is 500 ms.
- Error message RHxx133 is displayed if only the Display, for monitoring the receive cycle, is activated. Start the Display after starting the External Device communication. Use the [Start Time] to adjust the Display startup time. For details, refer to the GP-Pro EX Reference Manual.

■ Communication time chart

Basic parameter group (PG) setting example and communication time chart.

- Read request and cycle rate

Example 1

Setup description

Setup Items	Setting value
RX List	ON
Read Request	ON (Allow)
Cycle Rate	100ms

Time chart

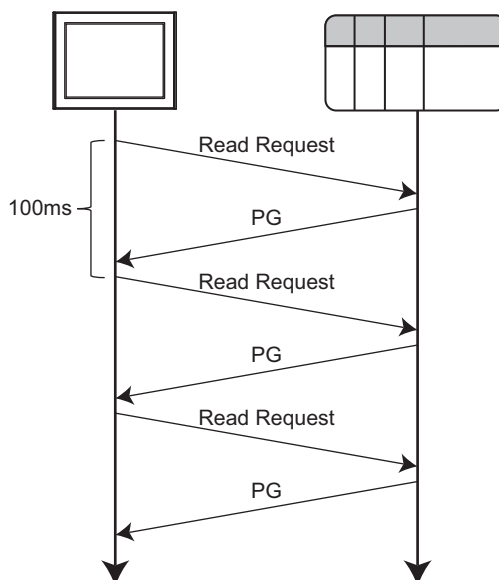

Example 2

Setup description

Setup Items	Setting value
RX List	ON
Read Request	OFF (Prevent)
Cycle Rate	100ms

Time chart

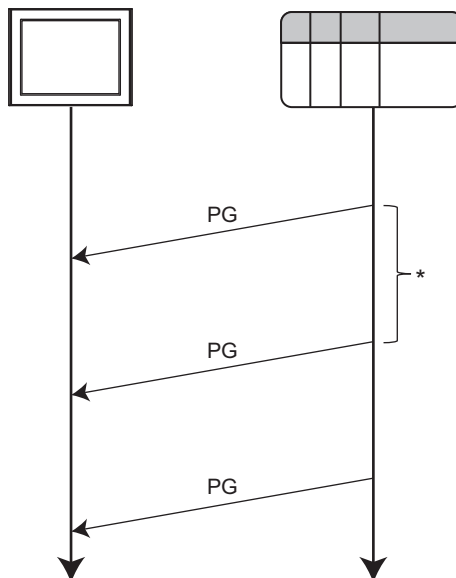

* Set the External Device setting cycle to 100 ms.

Example 3

Setup description

Setup Items	Setting value
RX List	ON
Read Request	ON (Allow)
Cycle Rate	100ms

Time chart

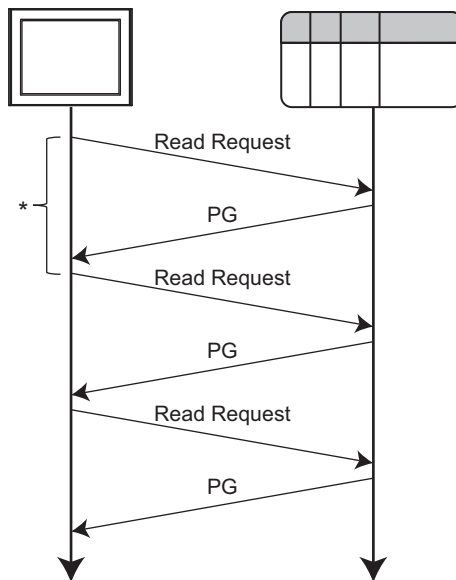

* Screen update cycle or D-Script operation cycle

- Write request and cycle rate

Example 1

Setup description

Setup Items	Setting value
TX List	ON
Cycle Rate	100ms

Time chart

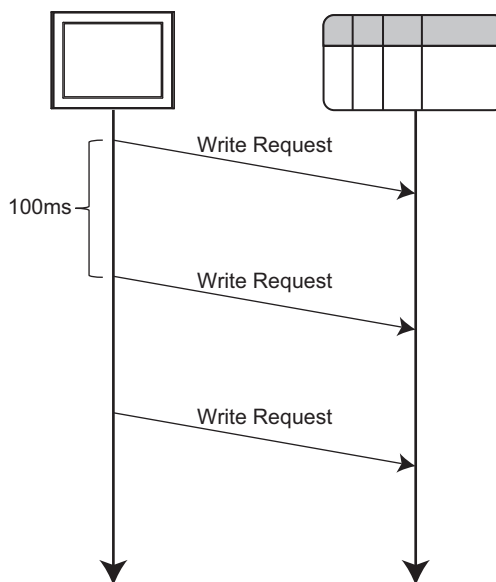

NOTE

- After the Display is started, the Write Request value is 0 until writing is started.

Example 2

Setup description

Setup Items	Setting value
TX List	ON
Cycle Rate	0ms

Time chart

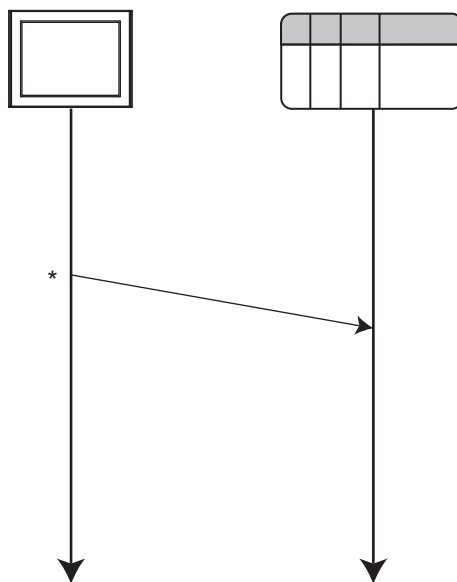

* Timing when value is confirmed on the Display screen or when D-Script is written.

3 Click [Add].

Add Data type

Data type: STRUCT

Name:

PreDefined PGNs: Please select PGN from list Sort by Name

Description:

PGN: 0

Length: 1

Default Priority: 1

	SPN	Data Type	Description	Length (Bits)	Byte Offset	Bit Offset	Conversion
*	0			1	0	0	<input type="checkbox"/>

OK Cancel

4 Set up the data type and click [OK].

Add Data type

Data type: STRUCT

Name: HCDI1

PreDefined PGNs: 37376 | HCDI1 | Aftertreatment 1 Hydrocarbon Doser Information Sort by Name

Description: Aftertreatment 1 Hydrocarbon Doser Information 1

PGN: 37376

Length: 8

Default Priority: 6

	SPN	Data Type	Description	Length (Bits)	Byte Offset	Bit Offset	Conversion
▶	5505	WORD	Requested Fuel Mass Rate	16	0	0	<input checked="" type="checkbox"/>
	5506	BYTE	HC Doser Status	3	2	0	<input type="checkbox"/>
	5507	BYTE	HC Doser Injecting Status	2	2	3	<input type="checkbox"/>
	5508	BYTE	Diagnostic Status of HC Doser	3	2	5	<input type="checkbox"/>
	5509	BYTE	Hydrocarbon Doser Purging Requi...	2	3	0	<input type="checkbox"/>
*	0			1	0	0	<input type="checkbox"/>

OK Cancel

◆ Setup Items in the Add Data Type Dialog Box

SPN	Data Type	Description	Length (Bits)	Byte Offset	Bit Offset	Conversion
5505	WORD	Requested Fuel Mass Rate	16	0	0	<input checked="" type="checkbox"/>
5506	BYTE	HC Doser Status	3	2	0	<input type="checkbox"/>
5507	BYTE	HC Doser Injecting Status	2	2	3	<input type="checkbox"/>
5508	BYTE	Diagnostic Status of HC Doser	3	2	5	<input type="checkbox"/>
5509	BYTE	Hydrocarbon Doser Purging Requi...	2	3	0	<input type="checkbox"/>
* 0			1	0	0	<input type="checkbox"/>

Setup Items	Setup Description
Name	Enter the name of the parameter group (PG). Supported characters for the name are as follows. 0-9 A-Z a-z _ [] () . , /
PreDefined PGNs	From the list select an existing parameter group (PG) which forms the basis of the data type to add.
Description	Enter a description, up to 1024 single-byte characters, for the data type to add.
PGN	Enter the number of the parameter group (PG).
Length	Enter the data length of the parameter group (PG).
Default Priority	Enter the priority of the parameter group (PG).
SPN	Enter the number of the suspect parameter (SP).
Data Type	Enter the data type of the suspect parameter (SP).
Length (bit)	Enter the data length (in bits) of the suspect parameter (SP).
Byte Offset	Enter the offset position (in bytes) of the suspect parameter (SP).
Bit Offset	Enter the offset position (in bits) of the suspect parameter (SP).
Conversion	Set the conversion function of the suspect parameter (SP).

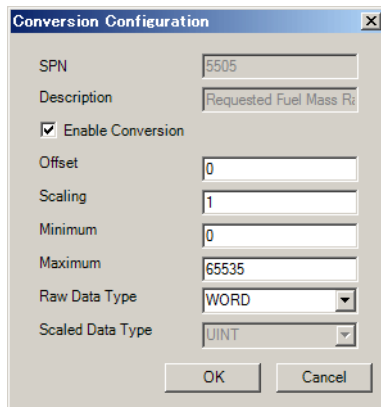

Setup Items	Setup Description
Offset	Enter the conversion offset.
Scaling	Enter the magnification for the conversion.
Minimum	Enter the minimum value of data after conversion.
Maximum	Enter the maximum value of data after conversion.
Raw Data Type	Set the data type before conversion.
Scaled Data Type	The converted data type is displayed.

NOTE

- Devices with the BYTE Array data type are not eligible for conversion.
- When copying and pasting between GP-Pro EX projects, or from the [Project] menu using [Utility]-[Copy from Another Project], address settings for the copied screen change to "Undefined".
 Before copying, match the contents of the [RX/TX List] tab and [Data Type] tab with the copy source project command.
 From the copy source project, output the data types in the [Data Type] tab with the [Export] button, and in the copy destination project input the data types with the [Import] button. Next, in the [RX/TX List] tab add the PGN to use on the screen.

7 Device Code and Address Code

Device and address codes are not available.

8 Error Messages

Error messages are displayed on the Display screen as follows: "No. : Device Name: Error Message (Error Occurrence Area)". Each description is shown below.

Item	Description
No.	Error number
Device Name	Name of the External Device where an error has occurred. Device/PLC name is the title of the External Device set with GP Pro-EX. (Initial value [PLC1])
Error Message	Displays messages related to an error that has occurred.
Error Occurrence Area	Displays the IP address or device address of the External Device where an error has occurred, or error codes received from the External Device. <div style="border: 1px solid black; padding: 2px; display: inline-block; margin-top: 5px;">NOTE</div> <ul style="list-style-type: none"> • Device address is displayed as "Address: Device address". • Received error codes are displayed as "Decimal [Hex]".

Examples of Error Messages

"RHAA035:PLC1: Error has been responded for device write command (Error Code: 2 [02H])"

NOTE

- Refer to your External Device manual for details on received error codes.
- Refer to "Display-related errors" in "Maintenance/Troubleshooting Guide" for details on the error messages common to the driver.

■ Error Messages Unique to External Device

Message ID	Error Message	Description
RHxx128	[External Device name]:[Device name] Out of range value in write request. (Tag name:%s)	Displays when writing a value out of range. Please enter a value inside the range.
RHxx129	Failed to read access to the J1939 unit memory.	Reboot the system. If the error persists, please contact your supplier. If errors occur frequently, replace the J1939 unit as it may be damaged.
RHxx130	Failed to load PGN list (S00105.BIN).	No PGN list has been created for the Display project. In the [Individual Device Settings] dialog box, create a PGN list.
RHxx131	The J1939 unit has not been boot.	The J1939 unit is not responding to the driver's start command. Reboot the system. If the error persists, please contact your supplier.
RHxx132	The J1939 unit request has time-out.	The J1939 unit may be in use. Reduce the network load.
RHxx133	The J1939 unit has detected an error. (Code:% X)	Detection error on the J1939 unit communication protocol stack. For details, refer to " ■ Error Code (RHxx133)" (page 29).

■ Error Code (RHxx133)

Error No.	Description
*101H	An overrun in the transmit queue is occurred.
*102H	Starting the CAN controller failed.
*103H	Reseting the CAN controller failed.
*104H	Initializing the CAN controller failed.
*10CH	The CAN controller status has changed to error passive.
*10DH	The CAN controller status has changed to error active.
*10EH	A data overrun interrupt is occurred on CAN.
*10FH	An overrun in the receive queue is occurred.
*30BH	Unexpected BAM frame received.
*30CH	Unexpected RTS frame received
*30DH	Unexpected CTS frame received.
*30EH	Unexpected EOM frame received.
*30FH	Unexpected CA frame received.
*310H	Unexpected DT frame received.
*312H	Transmit timeout T0 is occurred.
*313H	Transmit timeout T2 is occurred.
*314H	Receive timeout T0 is occurred.
*315H	Receive timeout T1 is occurred.
*316H	Receive timeout T2 is occurred.
*319H	Sending a CA message failed.
*31AH	Sending a NACK message failed.
*40BH	The device is not able to start the CAN communication (starting CAN failed).
*40DH	The maximum number of nodes in the network (CNF_NWM_MAX_NODES_IN_NET) is exceeded.
*504H	An error occurred during registration of a request PGN.
*602H	The maximal number of receive messages is exceeded.
*603H	The maximal number of transmit messages is exceeded.
*60BH	A registered message wasn't received in the given time.
*60CH	A message couldn't be sent due to an overrun of the transmit queue.
*60DH	The length of the received message is too long for the receive buffer.
*A08H	An invalid target address was used (broadcast is not allowed).

NOTE

- When error message (RHxx133) appears, ERR LED lights up on the J1939 unit. To turn off the ERR LED, set J1939 internal device Error Reset (999_0.23) to 1, or reset the Display.

 ■ Internal Device for J1939 unit" (page 13)

